



SABIEDRĪBA AR IEROBEŽOTU ATBILDĪBU

KALME 4

BŪVMATERIĀLU TIRDZniecība

- SKRŪVES
- INSTRUMENTI
- STIPRINĀJUMI
- BŪVĶĪMIJA
- BŪVMATERIĀLI
- RITENI

CELTNIECĪBAS PREČU KATALOGS 2017

Ezermalas iela 9, Liepāja

Darba laiks: P.-Pk. 8:30-17:30

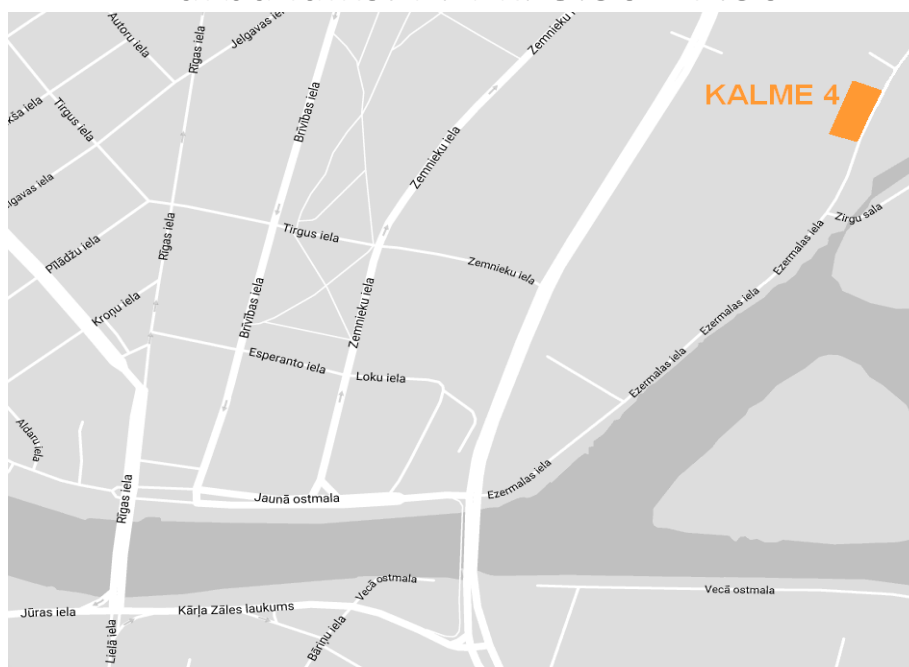

Transporta pakalpojumi

Liepāja	7.00 EUR
Ārpus pilsētas	0.30 EUR/km
+ izkraušana (ja nepieciešama)	

SKRŪVES	2
STIPRINĀJUMI	26
BŪVMATERIĀLI	42
INSTRUMENTI	54
BŪVĶĪMIJA	82
RITENI	84

SIA "Kalme 4"

Juridiskā adrese: Ezermalas iela 9, Liepāja, LV-3401

Reģistrācijas Nr.: 42103016563

PVN kods: LV 42103016563

A/S "Swedbank": LV86HABA0551001636702

A/S "SEB banka": LV18UNLA0012006467451

E-pasts: kalme4@apollo.lv

Mobilais tālrunis: +371 29570061

Veikala tālrunis: +371 63427400

Fakss: +371 63425233

SKRŪVES

Skrūves kokam	3
Skrūves reģipsim	5
Montāžas skrūves	6
Pašgriezošās skrūves	7
Jumta skrūves	8
Uzgriežņi	9
Paplākšņi	10
Bultskrūve DIN 933 balti cinkota	11
Bultskrūve DIN 931 balti cinkota	12
Bultskrūve DIN 933 HDG	13
Bultskrūve DIN 931 HDG	14
Bultskrūve DIN 933, DIN 931 melna	15
SB stiprinājums	16
Vītņstieņi	17
Šplintes	18
Skrūves ar metrisku vītņi	19
Bultskrūve DIN 912	20
Mēbeļu skrūves	21
A2	22

Skrūve kokam SPEC 18 balti vai dzelteni cinkota, PZ gremdgalva



ARTIKULS	CENA	ARTIKULS	CENA	ARTIKULS	CENA
s18 - 3 × 12 (1000 gab.)	0.003	s18 - 4 × 45 (500 gab.)	0.010	s18 - 5 × 45 (500 gab.)	0.016
s18 - 3 × 16 (1000 gab.)	0.004	s18 - 4 × 50 (500 gab.)	0.011	s18 - 5 × 50 (500 gab.)	0.016
s18 - 3 × 20 (1000 gab.)	0.004	s18 - 4 × 55 (500 gab.)	0.013	s18 - 5 × 60 (300 gab.)	0.021
s18 - 3 × 25 (1000 gab.)	0.004	s18 - 4 × 60 (500 gab.)	0.013	s18 - 5 × 70 (200 gab.)	0.024
s18 - 3 × 30 (1000 gab.)	0.005	s18 - 4 × 70 (300 gab.)	0.014	s18 - 5 × 80 (200 gab.)	0.028
s18 - 3 × 35 (1000 gab.)	0.006	s18 - 4.5 × 16 (1000 gab.)	0.006	s18 - 5 × 90 (200 gab.)	0.032
s18 - 3 × 40 (1000 gab.)	0.006	s18 - 4.5 × 20 (1000 gab.)	0.007	s18 - 5 × 100 (200 gab.)	0.036
s18 - 3.5 × 12 (1000 gab.)	0.004	s18 - 4.5 × 25 (1000 gab.)	0.008	s18 - 5 × 120 (100 gab.)	0.048
s18 - 3.5 × 16 (1000 gab.)	0.004	s18 - 4.5 × 30 (500 gab.)	0.009	s18 - 6 × 40 (200 gab.)	0.019
s18 - 3.5 × 20 (1000 gab.)	0.005	s18 - 4.5 × 35 (500 gab.)	0.010	s18 - 6 × 45 (200 gab.)	0.022
s18 - 3.5 × 25 (1000 gab.)	0.005	s18 - 4.5 × 40 (500 gab.)	0.011	s18 - 6 × 50 (200 gab.)	0.024
s18 - 3.5 × 30 (1000 gab.)	0.006	s18 - 4.5 × 45 (500 gab.)	0.013	s18 - 6 × 60 (200 gab.)	0.029
s18 - 3.5 × 35 (1000 gab.)	0.007	s18 - 4.5 × 50 (500 gab.)	0.014	s18 - 6 × 70 (200 gab.)	0.033
s18 - 3.5 × 40 (1000 gab.)	0.007	s18 - 4.5 × 55 (500 gab.)	0.016	s18 - 6 × 80 (200 gab.)	0.037
s18 - 3.5 × 45 (500 gab.)	0.008	s18 - 4.5 × 60 (300 gab.)	0.016	s18 - 6 × 90 (200 gab.)	0.044
s18 - 3.5 × 50 (500 gab.)	0.009	s18 - 4.5 × 70 (300 gab.)	0.020	s18 - 6 × 100 (200 gab.)	0.050
s18 - 4 × 16 (1000 gab.)	0.006	s18 - 4.5 × 80 (200 gab.)	0.022	s18 - 6 × 120 (100 gab.)	0.067
s18 - 4 × 20 (1000 gab.)	0.006	s18 - 5 × 20 (500 gab.)	0.010	s18 - 6 × 140 (100 gab.)	0.094
s18 - 4 × 25 (1000 gab.)	0.007	s18 - 5 × 25 (500 gab.)	0.010	s18 - 6 × 160 (100 gab.)	0.100
s18 - 4 × 30 (1000 gab.)	0.007	s18 - 5 × 30 (500 gab.)	0.011	s18 - 6 × 180 (100 gab.)	0.130
s18 - 4 × 35 (1000 gab.)	0.008	s18 - 5 × 35 (500 gab.)	0.013	s18 - 6 × 200 (100 gab.)	0.178
s18 - 4 × 40 (500 gab.)	0.009	s18 - 5 × 40 (500 gab.)	0.013		

Skrūve kokam TX dzelteni cinkota, TORX pašņēķjošā gremdgalva



ARTIKULS	CENA	ARTIKULS	CENA	ARTIKULS	CENA
TX - 3 × 30	0.010	TX - 4.5 × 80	0.037	TX - 6 × 220	0.381
TX - 3 × 35	0.011	TX - 5 × 40	0.022	TX - 6 × 240	0.393
TX - 3 × 40	0.013	TX - 5 × 50	0.028	TX - 6 × 260	0.448
TX - 3.5 × 30	0.011	TX - 5 × 60	0.032	TX - 6 × 280	0.516
TX - 3.5 × 35	0.013	TX - 5 × 70	0.036	TX - 6 × 300	0.539
TX - 3.5 × 40	0.014	TX - 5 × 80	0.043	TX - 8 × 80	0.104
TX - 3.5 × 50	0.018	TX - 5 × 90	0.054	TX - 8 × 100	0.125
TX - 4 × 30	0.012	TX - 5 × 100	0.061	TX - 8 × 120	0.160
TX - 4 × 35	0.014	TX - 5 × 120	0.083	TX - 8 × 140	0.256
TX - 4 × 40	0.015	TX - 6 × 70	0.052	TX - 8 × 160	0.316
TX - 4 × 50	0.018	TX - 6 × 80	0.063	TX - 8 × 180	0.358
TX - 4 × 60	0.023	TX - 6 × 100	0.086	TX - 8 × 200	0.432
TX - 4 × 70	0.031	TX - 6 × 120	0.105	TX - 8 × 240	0.605
TX - 4.5 × 40	0.018	TX - 6 × 140	0.126	TX - 8 × 280	0.760
TX - 4.5 × 50	0.021	TX - 6 × 160	0.162	TX - 8 × 320	1.006
TX - 4.5 × 60	0.027	TX - 6 × 180	0.229	TX - 8 × 360	1.203
TX - 4.5 × 70	0.033	TX - 6 × 200	0.248	TX - 8 × 400	1.354

**Skrūve kokam ar pusapaļu galvu
SPEC 17 balti cinkota, PZ un TORX**

ARTIKULS	CENA
s17 - 3 × 12	0.004
s17 - 3 × 16	0.006
s17 - 3 × 20	0.007
s17 - 3 × 25	0.007
s17 - 3 × 30	0.008
s17 - 3.5 × 12	0.007
s17 - 3.5 × 16	0.007
s17 - 3.5 × 20	0.009
s17 - 3.5 × 25	0.011
s17 - 3.5 × 30	0.013
s17 - 3.5 × 40	0.020
s17 - 4 × 12	0.009
s17 - 4 × 16	0.010
s17 - 4 × 20	0.012
s17 - 4 × 25	0.013
s17 - 4 × 30	0.013
s17 - 4 × 35	0.014
s17 - 4 × 40	0.014
s17 - 4 × 45	0.017
s17 - 4 × 50	0.017
s17 - 4 × 60	0.020
s17 - 4.5 × 20	0.014
s17 - 4.5 × 25	0.015
s17 - 4.5 × 30	0.016
s17 - 4.5 × 35	0.019
s17 - 4.5 × 40	0.022
s17 - 4.5 × 50	0.024
s17 - 4.5 × 60	0.034
s17 - 5 × 30	0.024
s17 - 5 × 35	0.026
s17 - 5 × 40	0.026
s17 - 5 × 45	0.026
s17 - 5 × 50	0.028
s17 - 5 × 60	0.030
s17 - 5 × 70	0.033
s17 - 5 × 80	0.050
s17 - 6 × 50	0.040
s17 - 6 × 60	0.064
s17 - 6 × 70	0.071
s17 - 6 × 80	0.085
s17 - 6 × 100	0.115
s17 - 6 × 120	0.139

**Skrūve kokam RUSPERT zaļa, TORX
T25 pašņēkņjošā gremdgalva**

ARTIKULS	CENA
TX RSPza - 4.5 × 40	0.032
TX RSPza - 4.5 × 50	0.039
TX RSPza - 4.5 × 60	0.046
TX RSPza - 4.5 × 70	0.051
TX RSPza - 4.5 × 80	0.057

Skrūve kokam ar WAF galvu dzeltenī cinkota, TORX



ARTIKULS	CENA	ARTIKULS	CENA
TX WAF - 6 × 80	0.101	TX WAF - 8 × 120	0.260
TX WAF - 6 × 100	0.123	TX WAF - 8 × 140	0.314
TX WAF - 6 × 120	0.165	TX WAF - 8 × 160	0.396
TX WAF - 6 × 140	0.201	TX WAF - 8 × 200	0.550
TX WAF - 6 × 160	0.254	TX WAF - 8 × 240	0.686
TX WAF - 6 × 180	0.330	TX WAF - 8 × 280	0.866
TX WAF - 6 × 200	0.378	TX WAF - 8 × 320	1.167
TX WAF - 8 × 80	0.186	TX WAF - 8 × 360	1.338
TX WAF - 8 × 100	0.218	TX WAF - 8 × 400	1.706

Skrūve kokam ar seškantu galvu DIN 571 balti cinkota

ARTIKULS	CENA	ARTIKULS	CENA
571 - 5 × 30	0.019	571 - 10 × 70	0.117
571 - 5 × 40	0.021	571 - 10 × 80	0.134
571 - 5 × 50	0.028	571 - 10 × 90	0.145
571 - 5 × 60	0.030	571 - 10 × 100	0.148
571 - 6 × 25	0.016	571 - 10 × 110	0.164
571 - 6 × 30	0.019	571 - 10 × 120	0.172
571 - 6 × 40	0.027	571 - 10 × 130	0.185
571 - 6 × 50	0.030	571 - 10 × 140	0.193
571 - 6 × 60	0.033	571 - 10 × 150	0.218
571 - 6 × 70	0.036	571 - 10 × 160	0.243
571 - 6 × 80	0.041	571 - 10 × 180	0.275
571 - 6 × 90	0.049	571 - 10 × 200	0.306
571 - 6 × 100	0.051	571 - 10 × 220	0.345
571 - 6 × 120	0.067	571 - 10 × 240	0.404
571 - 6 × 140	0.076	571 - 10 × 260	0.428
571 - 8 × 30	0.043	571 - 10 × 280	0.501
571 - 8 × 40	0.049	571 - 10 × 300	0.525
571 - 8 × 50	0.054	571 - 12 × 50	0.137
571 - 8 × 60	0.062	571 - 12 × 60	0.148
571 - 8 × 70	0.067	571 - 12 × 70	0.174
571 - 8 × 80	0.079	571 - 12 × 80	0.198
571 - 8 × 90	0.087	571 - 12 × 90	0.224
571 - 8 × 100	0.100	571 - 12 × 100	0.241
571 - 8 × 110	0.114	571 - 12 × 120	0.262
571 - 8 × 120	0.125	571 - 12 × 140	0.288
571 - 8 × 130	0.128	571 - 12 × 160	0.324
571 - 8 × 140	0.143	571 - 12 × 180	0.399
571 - 8 × 150	0.153	571 - 12 × 200	0.418
571 - 8 × 160	0.165	571 - 12 × 220	0.544
571 - 8 × 180	0.180	571 - 12 × 240	0.602
571 - 8 × 200	0.208	571 - 12 × 260	0.626
571 - 10 × 40	0.076	571 - 12 × 280	0.629
571 - 10 × 50	0.091	571 - 12 × 300	0.647
571 - 10 × 60	0.108		

Skrūve režģisim SPEC 27 (smalkā vītne ar urbi) melna fosfatizēta, PH2

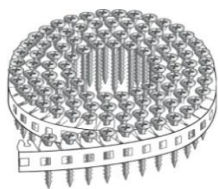
ARTIKULS	CENA
s27m - 3.5 × 25	0.008
s27m - 3.5 × 35	0.011
s27m - 3.5 × 45	0.013
s27m - 3.5 × 55	0.016

Skrūve režģisim lentās SPEC 25 melna fosfatizēta, PH2

ARTIKULS	CENA
s25m L - 3.5 × 25	0.011
s25m L - 3.5 × 41	0.013

Terašu skrūve RUSPERT tumši brūna, TORX T20 pašgredzīga

ARTIKULS	CENA
TER RSPbr - 4.2 × 45	0.019
TER RSPbr - 4.2 × 55	0.022
TER RSPbr - 4.8 × 90	0.050

Līmeņojoša rāmju skrūve balti cinkota, TORX T25 gredzīga

ARTIKULS	CENA
LMS - 6 × 70	0.070
LMS - 6 × 90	0.090
LMS - 6 × 110	0.120
LMS - 6 × 130	0.150

Enkurskrūve leņķiem RUSPERT, TORX T20

ARTIKULS	CENA
ENS RSP - 4.8 × 40	0.027

Skrūve režģisim SPEC 25 (smalkā vītne) melna fosfatizēta, PH2

ARTIKULS	CENA
s25m - 3.5 × 25 (1000 gab.)	0.005
s25m - 3.5 × 32 (1000 gab.)	0.006
s25m - 3.5 × 35 (1000 gab.)	0.006
s25m - 3.5 × 41 (1000 gab.)	0.007
s25m - 3.5 × 45 (500 gab.)	0.008
s25m - 3.5 × 51 (500 gab.)	0.009
s25m - 3.5 × 55 (500 gab.)	0.010
s25m - 3.8 × 64 (500 gab.)	0.013
s25m - 4.2 × 76 (250 gab.)	0.017
s25m - 4.8 × 90 (250 gab.)	0.027
s25m - 4.8 × 100 (250 gab.)	0.032



Skrūve režģisim SPEC 26 (rupjā vītne) melna fosfatizēta, PH2

ARTIKULS	CENA
s26m - 3.5 × 25 (1000 gab.)	0.005
s26m - 3.5 × 32 (1000 gab.)	0.006
s26m - 3.5 × 35 (1000 gab.)	0.006
s26m - 3.5 × 41 (1000 gab.)	0.007
s26m - 3.5 × 45 (500 gab.)	0.008
s26m - 3.5 × 51 (500 gab.)	0.009
s26m - 3.5 × 55 (500 gab.)	0.010
s26m - 3.8 × 64 (500 gab.)	0.013
s26m - 4.2 × 70 (250 gab.)	0.015
s26m - 4.2 × 76 (250 gab.)	0.016
s26m - 4.8 × 90 (250 gab.)	0.028
s26m - 4.8 × 100 (200 gab.)	0.031
s26m - 4.8 × 115 (200 gab.)	0.041
s26m - 4.8 × 125 (200 gab.)	0.044
s26m - 4.8 × 152 (100 gab.)	0.066

Skrūve saplāksnim SPEC 28 dzeltenī cinkota, PH2 pašgredzīgojošā gredzīga



ARTIKULS	CENA
s28dz - 4.2 × 30 (1000 gab.)	0.008
s28dz - 4.2 × 35 (1000 gab.)	0.009
s28dz - 4.2 × 41 (1000 gab.)	0.010
s28dz - 4.2 × 45 (1000 gab.)	0.012
s28dz - 4.2 × 51 (500 gab.)	0.013
s28dz - 4.2 × 55 (500 gab.)	0.014
s28dz - 4.2 × 65 (500 gab.)	0.018
s28dz - 4.2 × 75 (250 gab.)	0.020
s28dz - 4.8 × 90 (200 gab.)	0.027
s28dz - 4.8 × 100 (200 gab.)	0.039

Montāžas skrūve SPEC 22 melna fosfatizēta, PH2	
	
ARTIKULS	CENA
s22m - 3.5 × 11	0.005



Montāžas skrūve SPEC 23 balti cinkota, PH2	
	
ARTIKULS	CENA
s23 - 4.2 × 13	0.007
s23 - 4.2 × 16	0.008
s23 - 4.2 × 19	0.009
s23 - 4.2 × 25	0.011
s23 - 4.2 × 32	0.013
s23 - 4.2 × 41	0.015
s23 - 4.2 × 50	0.018
s23 - 4.2 × 65	0.021
s23 - 4.2 × 75	0.025



Dekoratīvais vāciņš 12/2.5mm	
	
ARTIKULS	CENA
183000 - RAL1035 bēšs	0.010
183001 - RAL8007 brūns	0.010
183002 - RAL9005 melns	0.010
183003 - RAL1015 dzelt.	0.010
183004 - RAL7035 g.pel.	0.010
183005 - RAL7037 t.pel.	0.010
183006 - RAL9010 balts	0.010

Montāžas skrūve SPEC 22 balti cinkota, PH2	
	
ARTIKULS	CENA
s22 - 3.5 × 11	0.007



Montāžas skrūve SPEC 23 melna fosfatizēta, PH2	
	
ARTIKULS	CENA
s23m - 4.2 × 13	0.008
s23m - 4.2 × 16	0.009
s23m - 4.2 × 19	0.010
s23m - 4.2 × 25	0.011
s23m - 4.2 × 32	0.013
s23m - 4.2 × 41	0.015
s23m - 4.2 × 50	0.018



Skrūve kokam ar padziļinātu galvu balti cinkota, PZ2	
	
ARTIKULS	CENA
SAP - 4.5 × 30	0.023
SAP - 4.5 × 35	0.026
SAP - 4.5 × 40	0.027
SAP - 4.5 × 45	0.031
SAP - 4.5 × 50	0.032
SAP - 4.5 × 60	0.064
SAP - 4.5 × 70	0.078
SAP - 4.5 × 80	0.100

Montāžas skrūve ar rupjo vītņi balti cinkota, PH2	
	
ARTIKULS	CENA
s23(rupjā v.) - 4.2x25	0.010
s23(rupjā v.) - 4.2x32	0.012
s23(rupjā v.) - 4.2x41	0.015
s23(rupjā v.) - 4.2x51	0.018
s23(rupjā v.) - 4.2x65	0.021

Montāžas skrūve SPEC 23 krāsota, PH2	
	
ARTIKULS	CENA
s23 RR20 - 4.2 × 19	0.030
s23 RR21 - 4.2 × 19	0.030
s23 RR22 - 4.2 × 19	0.030
s23 RR23 - 4.2 × 19	0.030
s23 RR29 - 4.2 × 19	0.030
s23 RR32 - 4.2 × 19	0.030

Tapskrūve SPEC 1 (metriskā/koka vītne) balti cinkota	
	
ARTIKULS	CENA
s1 - 8 × 60	0.080
s1 - 8 × 80	0.100
s1 - 8 × 100	0.130
s1 - 8 × 120	0.160
s1 - 8 × 140	0.210
s1 - 8 × 160	0.240
s1 - 8 × 200	0.310
s1 - 10 × 80	0.140
s1 - 10 × 100	0.160
s1 - 10 × 120	0.190
s1 - 10 × 140	0.230
s1 - 10 × 200	0.390

Montāžas skrūve ar rupjo vītņi CorrSeal brūna, PH2	
	
ARTIKULS	CENA
s23(rupjā v.) CS - 4.5 × 13	0.028
s23(rupjā v.) CS - 4.5 × 25	0.032
s23(rupjā v.) CS - 4.5 × 32	0.043
s23(rupjā v.) CS - 4.5 × 50	0.054
s23(rupjā v.) CS - 4.5 × 65	0.069
s23(rupjā v.) CS - 4.5 × 85	0.099

Montāžas skrūve SPEC 24 (ar urbi) balti cinkota, PH2	
	
ARTIKULS	CENA
s24 - 4.2 × 13	0.009
s24 - 4.2 × 16	0.010
s24 - 4.2 × 19	0.011
s24 - 4.2 × 25	0.012
s24 - 4.2 × 32	0.014
s24 - 4.2 × 41	0.018
s24 - 4.2 × 50	0.022

Cilpskrūve kokam SPEC 6 balti cinkota	
	
ARTIKULS	CENA
s6 - 12 × 90	0.850
s6 - 12 × 120	0.920
s6 - 12 × 160	1.050
s6 - 12 × 190	1.300
s6 - 12 × 230	1.510
s6 - 12 × 300	1.750
s6 - 12 × 350	1.960

Pašgriezoša skrūve DIN 7504-N (ar urbi) balti cinkota, PH	
	
ARTIKULS	CENA
metālam < 2.25mm	
7504-N - 3.5 × 9.5	0.010
7504-N - 3.5 × 13	0.010
7504-N - 3.5 × 16	0.011
7504-N - 3.5 × 19	0.012
7504-N - 3.5 × 25	0.014
metālam < 2.4mm	
7504-N - 3.9 × 13	0.011
7504-N - 3.9 × 16	0.012
7504-N - 3.9 × 19	0.013
7504-N - 3.9 × 25	0.015
metālam < 3mm	
7504-N - 4.2 × 13	0.014
7504-N - 4.2 × 16	0.014
7504-N - 4.2 × 19	0.016
7504-N - 4.2 × 25	0.018
7504-N - 4.2 × 32	0.023
7504-N - 4.2 × 38	0.024
metālam < 4mm	
7504-N - 4.8 × 13	0.020
7504-N - 4.8 × 16	0.021
7504-N - 4.8 × 19	0.023
7504-N - 4.8 × 25	0.025
7504-N - 4.8 × 32	0.029
7504-N - 4.8 × 38	0.034
7504-N - 4.8 × 50	0.042
metālam < 5mm	
7504-N - 5.5 × 19	0.035
7504-N - 5.5 × 25	0.037
7504-N - 5.5 × 32	0.042
7504-N - 5.5 × 38	0.047
7504-N - 5.5 × 50	0.059
metālam < 6mm	
7504-N - 6.3 × 19	0.045
7504-N - 6.3 × 25	0.051

Pašgriezoša skrūve ar spārniņiem SPEC 20 (ar urbi) balti cinkota, PH	
	
ARTIKULS	CENA
s20 - 4.8 × 32	0.050
s20 - 4.8 × 38	0.050
s20 - 4.8 × 45	0.060
s20 - 4.8 × 50	0.060
s20 - 5.5 × 38	0.070
s20 - 5.5 × 45	0.080
s20 - 5.5 × 55	0.100
s20 - 5.5 × 65	0.110
s20 - 6.3 × 60	0.130
s20 - 6.3 × 70	0.160
s20 - 6.3 × 85	0.200

Pašgriezoša skrūve DIN 7504-P (ar urbi) balti cinkota, PH	
	
ARTIKULS	CENA
metālam < 2.4mm	
7504-P - 3.9 × 13	0.010
7504-P - 3.9 × 16	0.010
7504-P - 3.9 × 19	0.011
7504-P - 3.9 × 25	0.014
7504-P - 3.9 × 32	0.016
7504-P - 3.9 × 38	0.018
metālam < 3mm	
7504-P - 4.2 × 13	0.011
7504-P - 4.2 × 16	0.012
7504-P - 4.2 × 19	0.013
7504-P - 4.2 × 25	0.016
7504-P - 4.2 × 32	0.018
7504-P - 4.2 × 38	0.020
metālam < 4mm	
7504-P - 4.8 × 16	0.016
7504-P - 4.8 × 19	0.017
7504-P - 4.8 × 25	0.019
7504-P - 4.8 × 32	0.022
7504-P - 4.8 × 38	0.024
7504-P - 4.8 × 50	0.030
metālam < 5mm	
7504-N - 5.5 × 19	0.028
7504-N - 5.5 × 25	0.035
7504-N - 5.5 × 32	0.041
7504-N - 5.5 × 38	0.049
7504-N - 5.5 × 50	0.058
metālam < 6mm	
7504-N - 6.3 × 19	0.038
7504-N - 6.3 × 25	0.042

Pašgriezoša skrūve DIN 7504-K (ar urbi) balti cinkota	
	
ARTIKULS	CENA
metālam < 2.25mm	
7504-K - 3.5 × 16	0.012
metālam < 3mm	
7504-K - 4.2 × 13	0.013
7504-K - 4.2 × 16	0.014
7504-K - 4.2 × 19	0.015
7504-K - 4.2 × 25	0.018
metālam < 4mm	
7504-K - 4.8 × 16	0.020
7504-K - 4.8 × 19	0.021
7504-K - 4.8 × 25	0.024
7504-K - 4.8 × 32	0.028
7504-K - 4.8 × 38	0.031
7504-K - 4.8 × 50	0.039
metālam < 5mm	
7504-K - 5.5 × 19	0.029
7504-K - 5.5 × 25	0.031
7504-K - 5.5 × 32	0.036
7504-K - 5.5 × 38	0.040
7504-K - 5.5 × 50	0.046
metālam < 8mm	
7504-K - 5.5 × 75	0.060
7504-K - 5.5 × 90	0.080
7504-K - 5.5 × 120	0.110
metālam < 6mm	
7504-K - 6.3 × 19	0.041
7504-K - 6.3 × 25	0.045
7504-K - 6.3 × 32	0.050
7504-K - 6.3 × 38	0.056
7504-K - 6.3 × 50	0.070

Pašgriezoša skrūve DIN 7981 balti cinkota, PZ un PH			
			
ARTIKULS	CENA	ARTIKULS	CENA
7981 - 2.9 × 9.5	0.006	7981 - 4.8 × 19	0.023
7981 - 2.9 × 13	0.006	7981 - 4.8 × 25	0.025
7981 - 2.9 × 16	0.007	7981 - 4.8 × 32	0.026
7981 - 3.5 × 13	0.010	7981 - 4.8 × 38	0.032
7981 - 3.5 × 16	0.013	7981 - 4.8 × 50	0.040
7981 - 3.5 × 19	0.013	7981 - 5.5 × 16	0.027
7981 - 3.5 × 25	0.013	7981 - 5.5 × 19	0.028
7981 - 3.5 × 32	0.016	7981 - 5.5 × 25	0.030
7981 - 3.5 × 38	0.019	7981 - 5.5 × 32	0.038
7981 - 4.2 × 13	0.012	7981 - 5.5 × 38	0.046
7981 - 4.2 × 16	0.014	7981 - 5.5 × 50	0.058
7981 - 4.2 × 19	0.015	7981 - 6.3 × 16	0.037
7981 - 4.2 × 25	0.021	7981 - 6.3 × 19	0.038
7981 - 4.2 × 32	0.023	7981 - 6.3 × 25	0.050
7981 - 4.2 × 38	0.026	7981 - 6.3 × 32	0.063
7981 - 4.8 × 13	0.016	7981 - 6.3 × 38	0.080
7981 - 4.8 × 16	0.017	7981 - 6.3 × 50	0.101

Jumta skrūve SPEC 32 (skārds/skārds, koks) balti cinkota, 8mm HEX galva



ARTIKULS	CENA
s32 - 4.8 × 20	0.040
s32 - 4.8 × 28	0.040
s32 - 4.8 × 35	0.040
s32 - 4.8 × 50	0.060
s32 - 4.8 × 70	0.080

Jumta skrūve SPEC 32 (metāls < 3mm) balti cinkota, 8mm HEX galva



ARTIKULS	CENA
s32 3mm - 4.8 × 19	0.040
s32 3mm - 4.8 × 25	0.040
s32 3mm - 4.8 × 32	0.040
s32 3mm - 4.8 × 38	0.040

Jumta skrūve SPEC 32 (metāls < 5mm) balti cinkota, 8mm HEX galva



ARTIKULS	CENA
s32 5mm - 5.5 × 25	0.040
s32 5mm - 5.5 × 32	0.040
s32 5mm - 5.5 × 38	0.050
s32 5mm - 5.5 × 45	0.050

Jumta skrūve SPEC 32 (metāls < 6mm) balti cinkota, 10mm HEX galva



ARTIKULS	CENA
s32 6mm - 6.3 × 25	0.050
s32 6mm - 6.3 × 32	0.060
s32 6mm - 6.3 × 38	0.060
s32 6mm - 6.3 × 45	0.100

Jumta skrūve SPEC 32 (metāls < 8mm) balti cinkota, 8mm HEX galva



ARTIKULS	CENA
s32 8mm - 5.5 × 75	0.070
s32 8mm - 5.5 × 90	0.110
s32 8mm - 5.5 × 120	0.140

Jumta skrūve SPEC 32 (metāls < 12mm) balti cinkota, 8mm HEX galva



ARTIKULS	CENA
s32 12mm - 5.5 × 32	0.050
s32 12mm - 5.5 × 35	0.060
s32 12mm - 5.5 × 38	0.060
s32 12mm - 5.5 × 50	0.080

Jumta skrūve SPEC 32 (metāls < 16mm) CorrSeal, 8mm HEX galva



ARTIKULS	CENA
s32 16mm - 6.3 × 38	0.120
s32 16mm - 6.3 × 50	0.140
s32 16mm - 6.3 × 65	0.160

Skrūve "sendviča" tipa paneļu stiprināšanai (metāls < 12mm) balti cinkota, 8mm HEX galva



ARTIKULS	CENA
SP 12mm - 5.5/6.3 × 70	0.130
SP 12mm - 5.5/6.3 × 90	0.160
SP 12mm - 5.5/6.3 × 110	0.190
SP 12mm - 5.5/6.3 × 125	0.220
SP 12mm - 5.5/6.3 × 150	0.300
SP 12mm - 5.5/6.3 × 185	0.440
SP 12mm - 5.5/6.3 × 200	0.480
SP 12mm - 5.5/6.3 × 230	0.580
SP 12mm - 5.5/6.3 × 250	0.680
SP 12mm - 5.5/6.3 × 300	0.930

Jumta skrūve SPEC 32 (metāls < 3mm) krāsota, 8mm HEX galva



ARTIKULS	CENA
s32 3mm RR11 - 4.8 × 19	0.050
s32 3mm RR20 - 4.8 × 19	0.050
s32 3mm RR21 - 4.8 × 19	0.050
s32 3mm RR22 - 4.8 × 19	0.050
s32 3mm RR23 - 4.8 × 19	0.050
s32 3mm RR29 - 4.8 × 19	0.050
s32 3mm RR30 - 4.8 × 19	0.050
s32 3mm RR32 - 4.8 × 19	0.050
s32 3mm RR33 - 4.8 × 19	0.050
s32 3mm RR35 - 4.8 × 19	0.050
s32 3mm RR37 - 4.8 × 19	0.050
s32 3mm RR750 - 4.8 × 19	0.050

Jumta skrūve SPEC 32 (skārds/skārds, koks) krāsota, 8mm HEX galva







ARTIKULS	CENA
s32 RR11 - 4.8 × 20	0.050
s32 RR20 - 4.8 × 20	0.050
s32 RR21 - 4.8 × 20	0.050
s32 RR22 - 4.8 × 20	0.050
s32 RR23 - 4.8 × 20	0.050
s32 RR25 - 4.8 × 20	0.050
s32 RR28 - 4.8 × 20	0.050
s32 RR29 - 4.8 × 20	0.050
s32 RR30 - 4.8 × 20	0.050
s32 RR31 - 4.8 × 20	0.050
s32 RR32 - 4.8 × 20	0.050
s32 RR33 - 4.8 × 20	0.050
s32 RR35 - 4.8 × 20	0.050
s32 RR37 - 4.8 × 20	0.050
s32 RR40 - 4.8 × 20	0.050
s32 RR41 - 4.8 × 20	0.050
s32 RR750 - 4.8 × 20	0.050
s32 RR11 - 4.8 × 28	0.040
s32 RR20 - 4.8 × 28	0.040
s32 RR21 - 4.8 × 28	0.040
s32 RR22 - 4.8 × 28	0.040
s32 RR23 - 4.8 × 28	0.040
s32 RR25 - 4.8 × 28	0.040
s32 RR28 - 4.8 × 28	0.040
s32 RR29 - 4.8 × 28	0.040
s32 RR30 - 4.8 × 28	0.040
s32 RR31 - 4.8 × 28	0.040
s32 RR32 - 4.8 × 28	0.040
s32 RR33 - 4.8 × 28	0.040
s32 RR35 - 4.8 × 28	0.040
s32 RR37 - 4.8 × 28	0.040
s32 RR40 - 4.8 × 28	0.040
s32 RR41 - 4.8 × 28	0.040
s32 RR750 - 4.8 × 28	0.040
s32 RR11 - 4.8 × 35	0.050
s32 RR20 - 4.8 × 35	0.050
s32 RR21 - 4.8 × 35	0.050
s32 RR22 - 4.8 × 35	0.050
s32 RR23 - 4.8 × 35	0.050
s32 RR25 - 4.8 × 35	0.050
s32 RR29 - 4.8 × 35	0.050
s32 RR32 - 4.8 × 35	0.050
s32 RR33 - 4.8 × 35	0.050
s32 RR35 - 4.8 × 35	0.050
s32 RR37 - 4.8 × 35	0.050
s32 RR750 - 4.8 × 35	0.050



ETERNIT skrūve krāsota, TORX T25



ARTIKULS	CENA
ETERNIT - 6 × 100	0.090



Uzgrieznis DIN 934 8 balti cinkots		
		
ARTIKULS	CENA	
934 8 - M2	0.003	
934 8 - M3	0.003	
934 8 - M4	0.004	
934 8 - M5	0.004	
934 8 - M6	0.006	
934 8 - M8	0.012	
934 8 - M10	0.026	
934 8 - M12	0.040	
934 8 - M14	0.055	
934 8 - M16	0.079	
934 8 - M18	0.100	
934 8 - M20	0.131	
934 8 - M22	0.200	
934 8 - M24	0.248	
934 8 - M27	0.457	
934 8 - M30	0.589	
934 8 - M33	0.744	
934 8 - M36	1.040	
934 8 - M42	1.930	
934 8 - M48	3.080	



Uzgrieznis DIN 934 8 HDG (karsti cinkots)		
		
ARTIKULS	CENA	
934 8 HDG - M6	0.011	
934 8 HDG - M8	0.020	
934 8 HDG - M10	0.064	
934 8 HDG - M12	0.088	
934 8 HDG - M16	0.160	
934 8 HDG - M20	0.242	
934 8 HDG - M24	0.411	
935 8 HDG - M27	0.678	
936 8 HDG - M30	0.860	



Kausuzgrieznis DIN 1587 balti cinkots		
		
ARTIKULS	CENA	
1587 - M4	0.024	
1587 - M5	0.025	
1587 - M6	0.026	
1587 - M8	0.059	
1587 - M10	0.118	
1587 - M12	0.178	
1587 - M16	0.491	
1587 - M20	0.950	
1587 - M24	1.320	

Uzgrieznis DIN 934 10 melns		
		
ARTIKULS	CENA	
934m 10 - M6	0.012	
934m 10 - M8	0.021	
934m 10 - M10	0.036	
934m 10 - M12	0.064	
934m 10 - M16	0.100	
934m 10 - M20	0.158	
934m 10 - M24	0.460	



Uzgrieznis DIN 934 12 melns		
		
ARTIKULS	CENA	
934 12 - M8	0.087	
934 12 - M10	0.095	
934 12 - M12	0.137	
934 12 - M16	0.335	
934 12 - M20	0.835	
934 12 - M24	1.550	
934 12 - M30	2.400	



Pagarināts uzgrieznis DIN 6334 balti cinkots		
		
ARTIKULS	CENA	
6334 - M6	0.060	
6334 - M8	0.100	
6334 - M10	0.160	
6334 - M12	0.280	
6334 - M16	0.650	
6334 - M20	1.540	
6334 - M24	2.560	

Plānais uzgrieznis DIN 439 balti cinkots		
		
ARTIKULS	CENA	
439 - M6	0.010	
439 - M8	0.025	
439 - M10	0.033	
439 - M12	0.049	
439 - M16	0.086	
439 - M20	0.159	

Kontruzgrieznis DIN 985 8 balti cinkots		
		
ARTIKULS	CENA	
985 8 - M3	0.008	
985 8 - M4	0.009	
985 8 - M5	0.010	
985 8 - M6	0.011	
985 8 - M8	0.020	
985 8 - M10	0.046	
985 8 - M12	0.064	
985 8 - M14	0.114	
985 8 - M16	0.139	
985 8 - M18	0.228	
985 8 - M20	0.319	
985 8 - M22	0.484	
985 8 - M24	0.585	
985 8 - M27	0.810	
985 8 - M30	0.987	

Uzgrieznis DIN 934 misiņa		
		
ARTIKULS	CENA	
934mi - M6	0.124	
934mi - M8	0.249	
934mi - M10	0.535	
934mi - M12	0.746	

Uzgrieznis metināšanai DIN 929 melns		
		
ARTIKULS	CENA	
929 - M6	0.025	
929 - M8	0.040	
929 - M10	0.062	
929 - M12	0.087	
929 - M16	0.194	

Uzgrieznis ar paplāksni DIN 6923 balti cinkots		
		
ARTIKULS	CENA	
6923 - M5	0.014	
6923 - M6	0.017	
6923 - M8	0.032	
6923 - M10	0.046	
6923 - M12	0.079	

Spārnuzgrieznis DIN 315 balti cinkots	
	
ARTIKULS	CENA
315 - M4	0.060
315 - M5	0.060
315 - M6	0.070
315 - M8	0.090
315 - M10	0.120
315 - M12	0.220

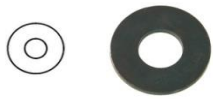
Paplāksne DIN 6340 melna	
	
ARTIKULS	CENA
6340m - M6	0.083
6340m - M8	0.133
6340m - M10	0.200
6340m - M12	0.280
6340m - M16	0.584
6340m - M20	1.070
6340m - M24	1.873
6340m - M30	2.090

Paplatināta paplāksne DIN 440 balti cinkota	
	
ARTIKULS	CENA
440 - M6	0.018
440 - M8	0.041
440 - M10	0.061
440 - M12	0.123
440 - M16	0.239
440 - M20	0.422
440 - M24	0.793

Kvadrātveida paplāksne DIN 436 balti cinkota	
	
ARTIKULS	CENA
436 - M8	0.103
436 - M10	0.115
436 - M12	0.195
436 - M16	0.343
436 - M20	0.616
436 - M24	1.436

Paplāksne DIN 125 balti cinkota	
	
ARTIKULS	CENA
125 - M3	0.002
125 - M4	0.002
125 - M5	0.003
125 - M6	0.004
125 - M8	0.006
125 - M10	0.011
125 - M12	0.017
125 - M14	0.025
125 - M16	0.030
125 - M18	0.041
125 - M20	0.048
125 - M22	0.063
125 - M24	0.091
125 - M27	0.110
125 - M30	0.139
125 - M33	0.385
125 - M36	0.360
125 - M42	0.690

Paplatināta paplāksne DIN 9021 balti cinkota	
	
ARTIKULS	CENA
9021 - M3	0.003
9021 - M4	0.004
9021 - M5	0.006
9021 - M6	0.009
9021 - M8	0.019
9021 - M10	0.034
9021 - M12	0.063
9021 - M14	0.097
9021 - M16	0.116
9021 - M18	0.199
9021 - M20	0.249
9021 - M22	0.378
9021 - M24	0.429
9021 - M27	0.680
9021 - M30	0.928

Paplāksne ar gumiju SPEC 15 balti cinkota	
	
ARTIKULS	CENA
s15 - 12/5.1mm	0.014
s15 - 14/5.2mm	0.019
s15 - 16/6.8mm	0.020

Paplāksne DIN 126 HDG (karsti cinkota)	
	
ARTIKULS	CENA
126 HDG - M6	0.016
126 HDG - M8	0.020
126 HDG - M10	0.025
126 HDG - M12	0.045
126 HDG - M16	0.092
126 HDG - M20	0.118
126 HDG - M24	0.186
126 HDG - M27	0.282
126 HDG - M30	0.319
126 HDG - M36	0.737

Atsperpaplāksne DIN 127 balti cinkota	
	
ARTIKULS	CENA
127 - M3	0.002
127 - M4	0.003
127 - M5	0.003
127 - M6	0.004
127 - M8	0.007
127 - M10	0.011
127 - M12	0.016
127 - M14	0.030
127 - M16	0.036
127 - M18	0.048
127 - M20	0.059
127 - M22	0.095
127 - M24	0.107
127 - M27	0.141
127 - M30	0.160
127 - M36	0.310

Zobpaplāksne DIN 6798 balti cinkota	
	
ARTIKULS	CENA
6798 - M3	0.009
6798 - M4	0.009
6798 - M5	0.010
6798 - M6	0.011
6798 - M8	0.019
6798 - M10	0.022
6798 - M12	0.031
6798 - M16	0.058
6798 - M20	0.097
6798 - M24	0.123

Bultskrūve ar seškantu galvu DIN 933 (pilna vītne) 8.8 balti cinkota



ARTIKULS	CENA	ARTIKULS	CENA	ARTIKULS	CENA
933 8.8 - M4 × 12	0.014	933 8.8 - M8 × 90	0.103	933 8.8 - M14 × 70	0.293
933 8.8 - M4 × 16	0.015	933 8.8 - M8 × 100	0.121	933 8.8 - M14 × 80	0.320
933 8.8 - M4 × 20	0.018	933 8.8 - M8 × 120	0.159	933 8.8 - M14 × 90	0.350
933 8.8 - M4 × 25	0.019	933 8.8 - M10 × 12	0.068	933 8.8 - M16 × 20	0.284
933 8.8 - M4 × 30	0.025	933 8.8 - M10 × 16	0.058	933 8.8 - M16 × 25	0.210
933 8.8 - M4 × 40	0.028	933 8.8 - M10 × 20	0.064	933 8.8 - M16 × 30	0.230
933 8.8 - M5 × 12	0.014	933 8.8 - M10 × 25	0.071	933 8.8 - M16 × 35	0.250
933 8.8 - M5 × 16	0.017	933 8.8 - M10 × 30	0.080	933 8.8 - M16 × 40	0.270
933 8.8 - M5 × 20	0.018	933 8.8 - M10 × 35	0.086	933 8.8 - M16 × 45	0.291
933 8.8 - M5 × 25	0.021	933 8.8 - M10 × 40	0.094	933 8.8 - M16 × 50	0.309
933 8.8 - M5 × 30	0.026	933 8.8 - M10 × 45	0.101	933 8.8 - M16 × 60	0.380
933 8.8 - M5 × 35	0.028	933 8.8 - M10 × 50	0.109	933 8.8 - M16 × 70	0.390
933 8.8 - M5 × 40	0.030	933 8.8 - M10 × 55	0.117	933 8.8 - M16 × 80	0.432
933 8.8 - M5 × 50	0.033	933 8.8 - M10 × 60	0.124	933 8.8 - M16 × 90	0.471
933 8.8 - M6 × 12	0.014	933 8.8 - M10 × 70	0.138	933 8.8 - M16 × 100	0.510
933 8.8 - M6 × 16	0.016	933 8.8 - M10 × 80	0.154	933 8.8 - M16 × 120	0.805
933 8.8 - M6 × 20	0.018	933 8.8 - M10 × 90	0.177	933 8.8 - M16 × 140	0.915
933 8.8 - M6 × 25	0.020	933 8.8 - M10 × 100	0.208	933 8.8 - M18 × 50	0.408
933 8.8 - M6 × 30	0.023	933 8.8 - M10 × 120	0.265	933 8.8 - M18 × 60	0.458
933 8.8 - M6 × 35	0.026	933 8.8 - M10 × 140	0.333	933 8.8 - M20 × 30	0.402
933 8.8 - M6 × 40	0.028	933 8.8 - M12 × 16	0.088	933 8.8 - M20 × 40	0.465
933 8.8 - M6 × 45	0.031	933 8.8 - M12 × 20	0.093	933 8.8 - M20 × 50	0.528
933 8.8 - M6 × 50	0.033	933 8.8 - M12 × 25	0.102	933 8.8 - M20 × 60	0.588
933 8.8 - M6 × 60	0.038	933 8.8 - M12 × 30	0.113	933 8.8 - M20 × 70	0.650
933 8.8 - M6 × 70	0.044	933 8.8 - M12 × 35	0.127	933 8.8 - M20 × 80	0.773
933 8.8 - M6 × 80	0.049	933 8.8 - M12 × 40	0.134	933 8.8 - M20 × 90	0.804
933 8.8 - M6 × 90	0.058	933 8.8 - M12 × 45	0.145	933 8.8 - M20 × 100	0.838
933 8.8 - M6 × 100	0.066	933 8.8 - M12 × 50	0.156	933 8.8 - M20 × 120	1.176
933 8.8 - M8 × 12	0.029	933 8.8 - M12 × 60	0.191	933 8.8 - M20 × 140	1.474
933 8.8 - M8 × 16	0.033	933 8.8 - M12 × 70	0.199	933 8.8 - M24 × 40	0.731
933 8.8 - M8 × 20	0.037	933 8.8 - M12 × 80	0.217	933 8.8 - M24 × 50	0.819
933 8.8 - M8 × 25	0.042	933 8.8 - M12 × 90	0.255	933 8.8 - M24 × 60	0.912
933 8.8 - M8 × 30	0.046	933 8.8 - M12 × 100	0.340	933 8.8 - M24 × 70	1.003
933 8.8 - M8 × 35	0.052	933 8.8 - M12 × 120	0.417	933 8.8 - M24 × 80	1.099
933 8.8 - M8 × 40	0.057	933 8.8 - M12 × 140	0.469	933 8.8 - M24 × 90	1.132
933 8.8 - M8 × 45	0.061	933 8.8 - M14 × 30	0.173	933 8.8 - M24 × 100	1.305
933 8.8 - M8 × 50	0.065	933 8.8 - M14 × 35	0.188	933 8.8 - M24 × 120	1.775
933 8.8 - M8 × 55	0.069	933 8.8 - M14 × 40	0.203	933 8.8 - M24 × 140	1.995
933 8.8 - M8 × 60	0.075	933 8.8 - M14 × 45	0.218	933 8.8 - M30 × 60	2.200
933 8.8 - M8 × 70	0.086	933 8.8 - M14 × 50	0.233	933 8.8 - M30 × 70	2.416
933 8.8 - M8 × 80	0.094	933 8.8 - M14 × 60	0.263	933 8.8 - M30 × 80	2.650

Bultskrūve ar seškantu galvu DIN 931 (nepilna vītne) 8.8 balti cinkota



ARTIKULS	CENA	ARTIKULS	CENA	ARTIKULS	CENA
931 8.8 - M6 × 50	0.042	931 8.8 - M12 × 150	0.486	931 8.8 - M20 × 130	1.173
931 8.8 - M6 × 60	0.051	931 8.8 - M12 × 160	0.531	931 8.8 - M20 × 140	1.246
931 8.8 - M6 × 70	0.058	931 8.8 - M12 × 180	0.644	931 8.8 - M20 × 160	1.593
931 8.8 - M6 × 80	0.065	931 8.8 - M12 × 200	0.750	931 8.8 - M20 × 180	1.769
931 8.8 - M6 × 90	0.073	931 8.8 - M14 × 60	0.304	931 8.8 - M20 × 200	2.041
931 8.8 - M6 × 100	0.076	931 8.8 - M14 × 70	0.338	931 8.8 - M20 × 220	2.676
931 8.8 - M6 × 120	0.120	931 8.8 - M14 × 80	0.369	931 8.8 - M20 × 240	3.227
931 8.8 - M8 × 50	0.081	931 8.8 - M14 × 90	0.404	931 8.8 - M20 × 260	4.150
931 8.8 - M8 × 60	0.089	931 8.8 - M14 × 100	0.439	931 8.8 - M20 × 280	4.591
931 8.8 - M8 × 70	0.106	931 8.8 - M14 × 120	0.625	931 8.8 - M20 × 300	5.378
931 8.8 - M8 × 80	0.114	931 8.8 - M14 × 140	0.705	931 8.8 - M22 × 80	1.124
931 8.8 - M8 × 90	0.132	931 8.8 - M16 × 60	0.359	931 8.8 - M22 × 100	1.319
931 8.8 - M8 × 100	0.146	931 8.8 - M16 × 70	0.404	931 8.8 - M22 × 120	1.538
931 8.8 - M8 × 110	0.159	931 8.8 - M16 × 80	0.469	931 8.8 - M24 × 70	1.069
931 8.8 - M8 × 120	0.173	931 8.8 - M16 × 90	0.495	931 8.8 - M24 × 80	1.165
931 8.8 - M8 × 130	0.185	931 8.8 - M16 × 100	0.541	931 8.8 - M24 × 90	1.220
931 8.8 - M8 × 140	0.198	931 8.8 - M16 × 110	0.587	931 8.8 - M24 × 100	1.383
931 8.8 - M8 × 160	0.224	931 8.8 - M16 × 120	0.633	931 8.8 - M24 × 110	1.494
931 8.8 - M8 × 180	0.574	931 8.8 - M16 × 130	0.681	931 8.8 - M24 × 120	1.605
931 8.8 - M8 × 200	0.631	931 8.8 - M16 × 140	0.726	931 8.8 - M24 × 130	1.708
931 8.8 - M10 × 60	0.155	931 8.8 - M16 × 150	0.888	931 8.8 - M24 × 140	1.811
931 8.8 - M10 × 70	0.176	931 8.8 - M16 × 160	0.939	931 8.8 - M24 × 160	2.038
931 8.8 - M10 × 80	0.197	931 8.8 - M16 × 170	1.271	931 8.8 - M24 × 180	2.487
931 8.8 - M10 × 90	0.216	931 8.8 - M16 × 180	1.149	931 8.8 - M24 × 200	2.726
931 8.8 - M10 × 100	0.237	931 8.8 - M16 × 200	1.372	931 8.8 - M24 × 220	3.328
931 8.8 - M10 × 110	0.258	931 8.8 - M16 × 220	2.134	931 8.8 - M24 × 240	4.437
931 8.8 - M10 × 120	0.278	931 8.8 - M16 × 240	2.159	931 8.8 - M24 × 260	5.000
931 8.8 - M10 × 130	0.298	931 8.8 - M16 × 260	2.543	931 8.8 - M24 × 280	5.244
931 8.8 - M10 × 140	0.320	931 8.8 - M16 × 280	2.900	931 8.8 - M24 × 300	5.500
931 8.8 - M10 × 150	0.339	931 8.8 - M16 × 300	3.062	931 8.8 - M27 × 100	2.419
931 8.8 - M10 × 160	0.368	931 8.8 - M18 × 60	0.527	931 8.8 - M27 × 120	2.782
931 8.8 - M10 × 180	0.545	931 8.8 - M18 × 70	0.582	931 8.8 - M27 × 140	3.145
931 8.8 - M10 × 200	0.740	931 8.8 - M18 × 80	0.641	931 8.8 - M27 × 160	3.496
931 8.8 - M12 × 60	0.222	931 8.8 - M18 × 90	0.697	931 8.8 - M30 × 80	3.122
931 8.8 - M12 × 70	0.252	931 8.8 - M18 × 100	0.751	931 8.8 - M30 × 90	2.824
931 8.8 - M12 × 80	0.281	931 8.8 - M20 × 60	0.590	931 8.8 - M30 × 100	2.973
931 8.8 - M12 × 90	0.311	931 8.8 - M20 × 70	0.650	931 8.8 - M30 × 120	3.398
931 8.8 - M12 × 100	0.343	931 8.8 - M20 × 80	0.773	931 8.8 - M30 × 140	3.824
931 8.8 - M12 × 110	0.372	931 8.8 - M20 × 90	0.804	931 8.8 - M30 × 160	4.798
931 8.8 - M12 × 120	0.401	931 8.8 - M20 × 100	0.908	931 8.8 - M30 × 180	5.341
931 8.8 - M12 × 130	0.432	931 8.8 - M20 × 110	1.036	931 8.8 - M30 × 200	5.613
931 8.8 - M12 × 140	0.460	931 8.8 - M20 × 120	1.102	931 8.8 - M36 × 120	4.425

Bultskrūve ar seškantu galvu DIN 933 (pilna vītne) 8.8 HDG (karsti cinkota)



ARTIKULS	CENA	ARTIKULS	CENA	ARTIKULS	CENA
933 8.8 HDG - M8 × 12		933 8.8 HDG - M12 × 30		933 8.8 HDG - M20 × 50	
933 8.8 HDG - M8 × 16		933 8.8 HDG - M12 × 35		933 8.8 HDG - M20 × 60	
933 8.8 HDG - M8 × 20		933 8.8 HDG - M12 × 40		933 8.8 HDG - M20 × 70	
933 8.8 HDG - M8 × 25		933 8.8 HDG - M12 × 45		933 8.8 HDG - M20 × 80	
933 8.8 HDG - M8 × 30		933 8.8 HDG - M12 × 50		933 8.8 HDG - M20 × 90	
933 8.8 HDG - M8 × 35		933 8.8 HDG - M12 × 60		933 8.8 HDG - M20 × 100	
933 8.8 HDG - M8 × 40		933 8.8 HDG - M12 × 70		933 8.8 HDG - M20 × 120	
933 8.8 HDG - M8 × 45		933 8.8 HDG - M12 × 80		933 8.8 HDG - M20 × 140	
933 8.8 HDG - M8 × 50		933 8.8 HDG - M12 × 90		933 8.8 HDG - M24 × 40	
933 8.8 HDG - M8 × 55		933 8.8 HDG - M12 × 100		933 8.8 HDG - M24 × 50	
933 8.8 HDG - M8 × 60		933 8.8 HDG - M12 × 120		933 8.8 HDG - M24 × 55	
933 8.8 HDG - M8 × 70		933 8.8 HDG - M12 × 140		933 8.8 HDG - M24 × 60	
933 8.8 HDG - M8 × 80		933 8.8 HDG - M16 × 20		933 8.8 HDG - M24 × 70	
933 8.8 HDG - M8 × 90		933 8.8 HDG - M16 × 25		933 8.8 HDG - M24 × 80	
933 8.8 HDG - M8 × 100		933 8.8 HDG - M16 × 30		933 8.8 HDG - M24 × 90	
933 8.8 HDG - M10 × 16		933 8.8 HDG - M16 × 35		933 8.8 HDG - M24 × 100	
933 8.8 HDG - M10 × 20		933 8.8 HDG - M16 × 40		933 8.8 HDG - M24 × 120	
933 8.8 HDG - M10 × 25		933 8.8 HDG - M16 × 45		933 8.8 HDG - M27 × 60	
933 8.8 HDG - M10 × 30		933 8.8 HDG - M16 × 50		933 8.8 HDG - M27 × 70	
933 8.8 HDG - M10 × 35		933 8.8 HDG - M16 × 55		933 8.8 HDG - M27 × 80	
933 8.8 HDG - M10 × 40		933 8.8 HDG - M16 × 60		933 8.8 HDG - M30 × 60	
933 8.8 HDG - M10 × 45		933 8.8 HDG - M16 × 70		933 8.8 HDG - M30 × 70	
933 8.8 HDG - M10 × 50		933 8.8 HDG - M16 × 80		933 8.8 HDG - M30 × 80	
933 8.8 HDG - M10 × 60		933 8.8 HDG - M16 × 90		933 8.8 HDG - M30 × 90	
933 8.8 HDG - M10 × 70		933 8.8 HDG - M16 × 100		933 8.8 HDG - M30 × 100	
933 8.8 HDG - M10 × 80		933 8.8 HDG - M16 × 120		933 8.8 HDG - M30 × 110	
933 8.8 HDG - M10 × 90		933 8.8 HDG - M16 × 140		933 8.8 HDG - M30 × 120	
933 8.8 HDG - M10 × 100		933 8.8 HDG - M20 × 30		933 8.8 HDG - M30 × 140	
933 8.8 HDG - M12 × 16		933 8.8 HDG - M20 × 35		933 8.8 HDG - M36 × 70	
933 8.8 HDG - M12 × 20		933 8.8 HDG - M20 × 40		933 8.8 HDG - M36 × 100	
933 8.8 HDG - M12 × 25		933 8.8 HDG - M20 × 45		933 8.8 HDG - M36 × 120	

Bultskrūve ar seškantu galvu DIN 931 (nepilna vītne) 8.8 HDG (karsti cinkota)



ARTIKULS	CENA	ARTIKULS	CENA	ARTIKULS	CENA
931 8.8 HDG - M8 × 40		931 8.8 HDG - M16 × 130		931 8.8 HDG - M24 × 300	
931 8.8 HDG - M8 × 50		931 8.8 HDG - M16 × 140		931 8.8 HDG - M24 × 320	
931 8.8 HDG - M8 × 60		931 8.8 HDG - M16 × 150		931 8.8 HDG - M24 × 360	
931 8.8 HDG - M8 × 65		931 8.8 HDG - M16 × 160		931 8.8 HDG - M24 × 400	
931 8.8 HDG - M8 × 70		931 8.8 HDG - M16 × 180		931 8.8 HDG - M27 × 80	
931 8.8 HDG - M8 × 80		931 8.8 HDG - M16 × 200		931 8.8 HDG - M27 × 90	
931 8.8 HDG - M8 × 90		931 8.8 HDG - M16 × 220		931 8.8 HDG - M27 × 100	
931 8.8 HDG - M8 × 100		931 8.8 HDG - M16 × 240		931 8.8 HDG - M27 × 110	
931 8.8 HDG - M10 × 40		931 8.8 HDG - M16 × 260		931 8.8 HDG - M27 × 120	
931 8.8 HDG - M10 × 50		931 8.8 HDG - M16 × 280		931 8.8 HDG - M27 × 130	
931 8.8 HDG - M10 × 60		931 8.8 HDG - M16 × 300		931 8.8 HDG - M27 × 140	
931 8.8 HDG - M10 × 70		931 8.8 HDG - M16 × 320		931 8.8 HDG - M27 × 150	
931 8.8 HDG - M10 × 80		931 8.8 HDG - M16 × 360		931 8.8 HDG - M27 × 160	
931 8.8 HDG - M10 × 90		931 8.8 HDG - M16 × 400		931 8.8 HDG - M27 × 180	
931 8.8 HDG - M10 × 100		931 8.8 HDG - M20 × 65		931 8.8 HDG - M27 × 200	
931 8.8 HDG - M10 × 110		931 8.8 HDG - M20 × 70		931 8.8 HDG - M27 × 220	
931 8.8 HDG - M10 × 120		931 8.8 HDG - M20 × 75		931 8.8 HDG - M27 × 240	
931 8.8 HDG - M10 × 130		931 8.8 HDG - M20 × 80		931 8.8 HDG - M27 × 260	
931 8.8 HDG - M10 × 140		931 8.8 HDG - M20 × 90		931 8.8 HDG - M27 × 280	
931 8.8 HDG - M10 × 160		931 8.8 HDG - M20 × 100		931 8.8 HDG - M27 × 300	
931 8.8 HDG - M10 × 180		931 8.8 HDG - M20 × 110		931 8.8 HDG - M30 × 80	
931 8.8 HDG - M12 × 45		931 8.8 HDG - M20 × 120		931 8.8 HDG - M30 × 90	
931 8.8 HDG - M12 × 50		931 8.8 HDG - M20 × 130		931 8.8 HDG - M30 × 100	
931 8.8 HDG - M12 × 55		931 8.8 HDG - M20 × 140		931 8.8 HDG - M30 × 110	
931 8.8 HDG - M12 × 60		931 8.8 HDG - M20 × 150		931 8.8 HDG - M30 × 120	
931 8.8 HDG - M12 × 65		931 8.8 HDG - M20 × 160		931 8.8 HDG - M30 × 130	
931 8.8 HDG - M12 × 70		931 8.8 HDG - M20 × 180		931 8.8 HDG - M30 × 140	
931 8.8 HDG - M12 × 75		931 8.8 HDG - M20 × 200		931 8.8 HDG - M30 × 150	
931 8.8 HDG - M12 × 80		931 8.8 HDG - M20 × 220		931 8.8 HDG - M30 × 160	
931 8.8 HDG - M12 × 90		931 8.8 HDG - M20 × 240		931 8.8 HDG - M30 × 180	
931 8.8 HDG - M12 × 100		931 8.8 HDG - M20 × 260		931 8.8 HDG - M30 × 200	
931 8.8 HDG - M12 × 110		931 8.8 HDG - M20 × 280		931 8.8 HDG - M30 × 220	
931 8.8 HDG - M12 × 120		931 8.8 HDG - M20 × 300		931 8.8 HDG - M30 × 240	
931 8.8 HDG - M12 × 130		931 8.8 HDG - M20 × 320		931 8.8 HDG - M30 × 260	
931 8.8 HDG - M12 × 140		931 8.8 HDG - M20 × 360		931 8.8 HDG - M30 × 280	
931 8.8 HDG - M12 × 150		931 8.8 HDG - M20 × 400		931 8.8 HDG - M30 × 300	
931 8.8 HDG - M12 × 160		931 8.8 HDG - M24 × 75		931 8.8 HDG - M30 × 320	
931 8.8 HDG - M12 × 180		931 8.8 HDG - M24 × 80		931 8.8 HDG - M30 × 360	
931 8.8 HDG - M12 × 200		931 8.8 HDG - M24 × 90		931 8.8 HDG - M30 × 400	
931 8.8 HDG - M12 × 220		931 8.8 HDG - M24 × 100		931 8.8 HDG - M36 × 110	
931 8.8 HDG - M12 × 240		931 8.8 HDG - M24 × 110		931 8.8 HDG - M36 × 120	
931 8.8 HDG - M12 × 260		931 8.8 HDG - M24 × 120		931 8.8 HDG - M36 × 130	
931 8.8 HDG - M16 × 55		931 8.8 HDG - M24 × 130		931 8.8 HDG - M36 × 140	
931 8.8 HDG - M16 × 60		931 8.8 HDG - M24 × 140		931 8.8 HDG - M36 × 150	
931 8.8 HDG - M16 × 65		931 8.8 HDG - M24 × 150		931 8.8 HDG - M36 × 160	
931 8.8 HDG - M16 × 70		931 8.8 HDG - M24 × 160		931 8.8 HDG - M36 × 180	
931 8.8 HDG - M16 × 75		931 8.8 HDG - M24 × 180		931 8.8 HDG - M36 × 200	
931 8.8 HDG - M16 × 80		931 8.8 HDG - M24 × 200		931 8.8 HDG - M36 × 220	
931 8.8 HDG - M16 × 90		931 8.8 HDG - M24 × 220		931 8.8 HDG - M36 × 240	
931 8.8 HDG - M16 × 100		931 8.8 HDG - M24 × 240		931 8.8 HDG - M36 × 260	
931 8.8 HDG - M16 × 110		931 8.8 HDG - M24 × 260		931 8.8 HDG - M36 × 280	
931 8.8 HDG - M16 × 120		931 8.8 HDG - M24 × 280		931 8.8 HDG - M36 × 300	

Bultskrūve ar sešskantu galvu DIN 933 (pilna vītne) 10.9 melna



ARTIKULS	CENA	ARTIKULS	CENA	ARTIKULS	CENA
933m 10.9 - M6 × 12		933m 10.9 - M10 × 20		933m 10.9 - M16 × 35	
933m 10.9 - M6 × 16		933m 10.9 - M10 × 25		933m 10.9 - M16 × 40	
933m 10.9 - M6 × 20		933m 10.9 - M10 × 30		933m 10.9 - M16 × 45	
933m 10.9 - M6 × 25		933m 10.9 - M10 × 35		933m 10.9 - M16 × 50	
933m 10.9 - M6 × 30		933m 10.9 - M10 × 40		933m 10.9 - M16 × 60	
933m 10.9 - M6 × 35		933m 10.9 - M10 × 50		933m 10.9 - M16 × 70	
933m 10.9 - M6 × 40		933m 10.9 - M12 × 25		933m 10.9 - M20 × 40	
933m 10.9 - M8 × 20		933m 10.9 - M12 × 30		933m 10.9 - M20 × 50	
933m 10.9 - M8 × 25		933m 10.9 - M12 × 35		933m 10.9 - M20 × 60	
933m 10.9 - M8 × 30		933m 10.9 - M12 × 40		933m 10.9 - M20 × 70	
933m 10.9 - M8 × 35		933m 10.9 - M12 × 45		933m 10.9 - M24 × 50	
933m 10.9 - M8 × 40		933m 10.9 - M12 × 50		933m 10.9 - M24 × 60	
933m 10.9 - M8 × 50		933m 10.9 - M16 × 30		933m 10.9 - M24 × 70	

Bultskrūve ar sešskantu galvu DIN 931 (nepilna vītne) 10.9 melna



ARTIKULS	CENA	ARTIKULS	CENA	ARTIKULS	CENA
931m 10.9 - M8 × 30		931m 10.9 - M12 × 80		931m 10.9 - M20 × 60	
931m 10.9 - M8 × 35		931m 10.9 - M12 × 90		931m 10.9 - M20 × 70	
931m 10.9 - M8 × 40		931m 10.9 - M12 × 100		931m 10.9 - M20 × 80	
931m 10.9 - M8 × 60		931m 10.9 - M12 × 120		931m 10.9 - M20 × 90	
931m 10.9 - M8 × 70		931m 10.9 - M12 × 140		931m 10.9 - M20 × 100	
931m 10.9 - M8 × 80		931m 10.9 - M16 × 50		931m 10.9 - M20 × 120	
931m 10.9 - M8 × 90		931m 10.9 - M16 × 55		931m 10.9 - M20 × 140	
931m 10.9 - M8 × 100		931m 10.9 - M16 × 60		931m 10.9 - M24 × 80	
931m 10.9 - M10 × 60		931m 10.9 - M16 × 65		931m 10.9 - M24 × 100	
931m 10.9 - M10 × 70		931m 10.9 - M16 × 70		931m 10.9 - M24 × 110	
931m 10.9 - M10 × 80		931m 10.9 - M16 × 80		931m 10.9 - M24 × 120	
931m 10.9 - M10 × 100		931m 10.9 - M16 × 90		931m 10.9 - M24 × 130	
931m 10.9 - M10 × 120		931m 10.9 - M16 × 100		931m 10.9 - M24 × 140	
931m 10.9 - M10 × 140		931m 10.9 - M16 × 110		931m 10.9 - M24 × 150	
931m 10.9 - M12 × 50		931m 10.9 - M16 × 120		931m 10.9 - M24 × 160	
931m 10.9 - M12 × 60		931m 10.9 - M16 × 130		931m 10.9 - M24 × 180	
931m 10.9 - M12 × 70		931m 10.9 - M16 × 140		931m 10.9 - M24 × 200	

SB stiprinājums ar iepriekš neslogotām bultskrūvēm (EN 15048-1) 8.8 HDG (karsti cinkots)

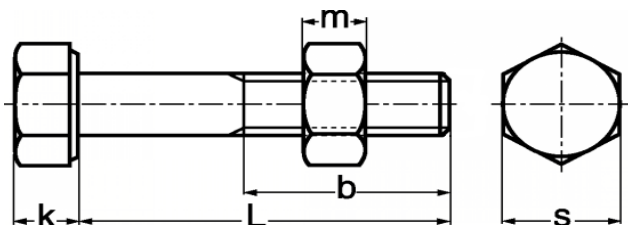

	M12	M16	M20	M24	M30
b (L < 125)	30 mm	38 mm	46 mm	54 mm	66 mm
b (125 < L < 200)	-	-	52 mm	60 mm	72 mm
k	7.5 mm	10 mm	12.5 mm	15 mm	18.7 mm
s	18 mm	24 mm	30 mm	36 mm	46 mm
m max	10.8 mm	14.8 mm	18 mm	21.5 mm	25.6 mm

1 komplekts ar nepilnu vītņi = 1x EN ISO 4014 + 1x EN ISO 4032

ARTIKULS	CENA	ARTIKULS	CENA	ARTIKULS	CENA
SB 8.8 HDG - M12 × 45		SB 8.8 HDG - M16 × 100		SB 8.8 HDG - M24 × 110	
SB 8.8 HDG - M12 × 50		SB 8.8 HDG - M20 × 65		SB 8.8 HDG - M24 × 120	
SB 8.8 HDG - M12 × 55		SB 8.8 HDG - M20 × 70		SB 8.8 HDG - M24 × 130	
SB 8.8 HDG - M12 × 60		SB 8.8 HDG - M20 × 75		SB 8.8 HDG - M30 × 90	
SB 8.8 HDG - M12 × 65		SB 8.8 HDG - M20 × 80		SB 8.8 HDG - M30 × 100	
SB 8.8 HDG - M12 × 70		SB 8.8 HDG - M20 × 90		SB 8.8 HDG - M30 × 110	
SB 8.8 HDG - M16 × 55		SB 8.8 HDG - M20 × 100		SB 8.8 HDG - M30 × 120	
SB 8.8 HDG - M16 × 60		SB 8.8 HDG - M20 × 110		SB 8.8 HDG - M30 × 130	
SB 8.8 HDG - M16 × 65		SB 8.8 HDG - M20 × 120		SB 8.8 HDG - M30 × 140	
SB 8.8 HDG - M16 × 70		SB 8.8 HDG - M20 × 130		SB 8.8 HDG - M30 × 150	
SB 8.8 HDG - M16 × 75		SB 8.8 HDG - M24 × 80		SB 8.8 HDG - M30 × 160	
SB 8.8 HDG - M16 × 80		SB 8.8 HDG - M24 × 90		SB 8.8 HDG - M30 × 180	
SB 8.8 HDG - M16 × 90		SB 8.8 HDG - M24 × 100			

1 komplekts ar pilnu vītņi = 1x EN ISO 4017 + 1x EN ISO 4032

ARTIKULS	CENA	ARTIKULS	CENA	ARTIKULS	CENA
SB 8.8 HDG - M12 × 30		SB 8.8 HDG - M16 × 45		SB 8.8 HDG - M20 × 50	
SB 8.8 HDG - M12 × 35		SB 8.8 HDG - M16 × 50		SB 8.8 HDG - M20 × 55	
SB 8.8 HDG - M12 × 40		SB 8.8 HDG - M20 × 30		SB 8.8 HDG - M20 × 60	
SB 8.8 HDG - M16 × 30		SB 8.8 HDG - M20 × 35		SB 8.8 HDG - M24 × 50	
SB 8.8 HDG - M16 × 35		SB 8.8 HDG - M20 × 40		SB 8.8 HDG - M24 × 60	
SB 8.8 HDG - M16 × 40		SB 8.8 HDG - M20 × 45		SB 8.8 HDG - M24 × 70	

Vītņstienis DIN 975 4.6 balti cinkots



ARTIKULS	CENA	ARTIKULS	CENA
975 4.6 - M4 × 1000	0.290		
975 4.6 - M5 × 1000	0.290		
975 4.6 - M6 × 1000	0.290	975 4.6 - M6 × 2000	0.580
975 4.6 - M8 × 1000	0.450	975 4.6 - M8 × 2000	0.900
975 4.6 - M10 × 1000	0.720	975 4.6 - M10 × 2000	1.440
975 4.6 - M12 × 1000	1.050	975 4.6 - M12 × 2000	2.100
975 4.6 - M14 × 1000	1.490	975 4.6 - M14 × 2000	2.980
975 4.6 - M16 × 1000	2.040	975 4.6 - M16 × 2000	4.080
975 4.6 - M18 × 1000	2.700	975 4.6 - M18 × 2000	5.400
975 4.6 - M20 × 1000	3.300	975 4.6 - M20 × 2000	6.600
975 4.6 - M22 × 1000	4.500	975 4.6 - M22 × 2000	10.900
975 4.6 - M24 × 1000	5.250	975 4.6 - M24 × 2000	10.500
975 4.6 - M27 × 1000	7.080	975 4.6 - M27 × 2000	14.160
975 4.6 - M30 × 1000	8.820	975 4.6 - M30 × 2000	17.640

Vītņstienis DIN 975 8.8 balti cinkots



ARTIKULS	CENA	ARTIKULS	CENA
975 8.8 - M10 × 1000	1.650	975 8.8 - M10 × 2000	2.330
975 8.8 - M12 × 1000	2.230	975 8.8 - M12 × 2000	3.360
975 8.8 - M14 × 1000	3.110		
975 8.8 - M16 × 1000	3.220	975 8.8 - M16 × 2000	6.550
975 8.8 - M18 × 1000	4.600		
975 8.8 - M20 × 1000	5.080	975 8.8 - M20 × 2000	10.180
975 8.8 - M22 × 1000	7.400		
975 8.8 - M24 × 1000	7.250	975 8.8 - M24 × 2000	14.800
975 8.8 - M27 × 1000	9.900		
975 8.8 - M30 × 1000	11.930	975 8.8 - M30 × 2000	23.850
		975 8.8 - M33 × 2000	29.500
		975 8.8 - M36 × 2000	34.900

Vītņstienis DIN 975 8.8 HDG (karsti cinkots)



ARTIKULS	CENA	ARTIKULS	CENA
975 8.8 HDG - M10 × 1000	2.450	975 8.8 HDG - M10 × 2000	4.900
975 8.8 HDG - M12 × 1000	3.200	975 8.8 HDG - M12 × 2000	6.400
975 8.8 HDG - M16 × 1000	5.530	975 8.8 HDG - M16 × 2000	9.270
975 8.8 HDG - M20 × 1000	8.860	975 8.8 HDG - M20 × 2000	15.630
975 8.8 HDG - M24 × 1000	13.640	975 8.8 HDG - M24 × 2000	23.810
975 8.8 HDG - M30 × 1000	24.410	975 8.8 HDG - M30 × 2000	37.840
		975 8.8 HDG - M36 × 2000	52.540

Vītņstienis 5.8 KEVA balti cinkots

SORMAT 

ARTIKULS	CENA
KEVA - M8 × 110	0.550
KEVA - M10 × 130	0.670
KEVA - M12 × 160	0.930
KEVA - M16 × 190	1.500
KEVA - M20 × 260	2.820
KEVA - M24 × 300	5.630

Vītņstienis Din 975 10.9 melns



ARTIKULS	CENA
975 10.9 - M6 × 1000	3.900
975 10.9 - M8 × 1000	3.960
975 10.9 - M10 × 1000	5.100
975 10.9 - M12 × 1000	6.550
975 10.9 - M16 × 1000	10.890
975 10.9 - M20 × 1000	14.630
975 10.9 - M24 × 1000	20.800
975 10.9 - M30 × 1000	46.400

Trapečvītnes vītņstienis cinkots



ARTIKULS	CENA
975TR - 16 × 1000	10.740
975TR - 20 × 1000	15.770
975TR - 24 × 1000	24.640
975TR - 30 × 1000	35.730

Apaļš trapečvītnes vītņstienis 88089 cinkots



ARTIKULS	CENA
88089TR - 16	6.620
88089TR - 20	8.560
88089TR - 24	11.790
88089TR - 30	17.380

Šplinte DIN 94 balti cinkota



ARTIKULS	CENA	ARTIKULS	CENA
94 - 2 × 16	0.017	94 - 4 × 40	0.046
94 - 2 × 20	0.018	94 - 4 × 50	0.049
94 - 2 × 25	0.020	94 - 4 × 63	0.061
94 - 2 × 32	0.022	94 - 4 × 71	0.073
94 - 2 × 40	0.024	94 - 5 × 32	0.066
94 - 2.5 × 16	0.020	94 - 5 × 40	0.071
94 - 2.5 × 20	0.022	94 - 5 × 50	0.089
94 - 2.5 × 25	0.024	94 - 5 × 63	0.102
94 - 2.5 × 32	0.026	94 - 5 × 80	0.168
94 - 2.5 × 40	0.030	94 - 5 × 100	0.214
94 - 3.2 × 20	0.025	94 - 6.3 × 50	0.165
94 - 3.2 × 25	0.028	94 - 6.3 × 63	0.204
94 - 3.2 × 32	0.031	94 - 6.3 × 71	0.220
94 - 3.2 × 40	0.036	94 - 8 × 50	0.326
94 - 3.2 × 50	0.042	94 - 8 × 63	0.375
94 - 4 × 25	0.035	94 - 8 × 80	0.435
94 - 4 × 32	0.039	94 - 8 × 100	0.500

Atsperšplinte DIN 11024 balti cinkota



ARTIKULS	CENA
11024 - 2 × 50	0.070
11024 - 3 × 60	0.100
11024 - 4 × 60	0.160
11024 - 5 × 85	0.380

Sprostapa DIN 11023 balti cinkota



ARTIKULS	CENA
11023 - 4.5 × 39	0.340
11023 - 6 × 39	0.370
11023 - 8 × 39	0.390
11023 - 10 × 39	0.430

Tapskrūve DIN 914 melna, HEX



ARTIKULS	CENA	ARTIKULS	CENA	ARTIKULS	CENA
914 - M4 × 6	0.028	914 - M6 × 6	0.033	914 - M8 × 16	0.073
914 - M4 × 8	0.033	914 - M6 × 8	0.041	914 - M8 × 20	0.086
914 - M4 × 10	0.039	914 - M6 × 10	0.049	914 - M8 × 30	0.129
914 - M4 × 12	0.046	914 - M6 × 12	0.057	914 - M10 × 10	0.069
914 - M4 × 16	0.053	914 - M6 × 16	0.064	914 - M10 × 12	0.077
914 - M5 × 6	0.034	914 - M6 × 20	0.078	914 - M10 × 16	0.099
914 - M5 × 8	0.040	914 - M6 × 25	0.093	914 - M10 × 20	0.121
914 - M5 × 10	0.042	914 - M6 × 30	0.104	914 - M10 × 25	0.160
914 - M5 × 12	0.044	914 - M8 × 8	0.054	914 - M10 × 30	0.199
914 - M5 × 16	0.058	914 - M8 × 10	0.060	914 - M10 × 40	0.274
914 - M5 × 20	0.066	914 - M8 × 12	0.066	914 - M12 × 30	0.223

Skrūve DIN 7991 10.9 melna, HEX



ARTIKULS	CENA	ARTIKULS	CENA	ARTIKULS	CENA
7991m 10.9 - M5 × 16	0.030	7991m 10.9 - M8 × 20	0.080	7991m 10.9 - M10 × 60	0.310
7991m 10.9 - M5 × 20	0.040	7991m 10.9 - M8 × 25	0.090	7991m 10.9 - M12 × 30	0.230
7991m 10.9 - M5 × 30	0.060	7991m 10.9 - M8 × 30	0.090	7991m 10.9 - M12 × 40	0.300
7991m 10.9 - M5 × 40	0.080	7991m 10.9 - M8 × 35	0.110	7991m 10.9 - M12 × 50	0.360
7991m 10.9 - M6 × 16	0.040	7991m 10.9 - M8 × 40	0.120	7991m 10.9 - M12 × 60	0.440
7991m 10.9 - M6 × 20	0.040	7991m 10.9 - M8 × 50	0.150	7991m 10.9 - M16 × 30	0.480
7991m 10.9 - M6 × 25	0.050	7991m 10.9 - M8 × 60	0.180	7991m 10.9 - M16 × 40	0.530
7991m 10.9 - M6 × 30	0.060	7991m 10.9 - M10 × 25	0.150	7991m 10.9 - M16 × 50	0.620
7991m 10.9 - M6 × 35	0.070	7991m 10.9 - M10 × 30	0.160	7991m 10.9 - M16 × 60	0.720
7991m 10.9 - M6 × 40	0.080	7991m 10.9 - M10 × 40	0.180	7991m 10.9 - M16 × 70	1.080
7991m 10.9 - M6 × 50	0.100	7991m 10.9 - M10 × 50	0.240	7991m 10.9 - M16 × 80	1.620

Skrūve DIN 84 balti cinkota, SL

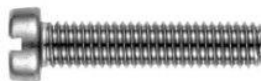

ARTIKULS	CENA	ARTIKULS	CENA	ARTIKULS	CENA
84 - M3 × 10	0.009	84 - M4 × 50	0.034	84 - M6 × 10	0.030
84 - M3 × 12	0.010	84 - M4 × 60	0.044	84 - M6 × 12	0.034
84 - M3 × 16	0.010	84 - M4 × 70	0.050	84 - M6 × 16	0.038
84 - M3 × 20	0.010	84 - M5 × 10	0.019	84 - M6 × 20	0.044
84 - M3 × 30	0.011	84 - M5 × 12	0.026	84 - M6 × 25	0.046
84 - M3 × 40	0.013	84 - M5 × 16	0.029	84 - M6 × 30	0.058
84 - M4 × 8	0.010	84 - M5 × 20	0.033	84 - M6 × 40	0.064
84 - M4 × 10	0.013	84 - M5 × 25	0.039	84 - M6 × 50	0.066
84 - M4 × 12	0.013	84 - M5 × 30	0.040	84 - M6 × 60	0.070
84 - M4 × 16	0.016	84 - M5 × 40	0.047	84 - M8 × 16	0.044
84 - M4 × 20	0.017	84 - M5 × 50	0.048	84 - M8 × 20	0.050
84 - M4 × 25	0.018	84 - M5 × 60	0.054	84 - M8 × 25	0.057
84 - M4 × 30	0.021	84 - M5 × 70	0.057	84 - M8 × 30	0.065
84 - M4 × 40	0.030	84 - M5 × 80	0.070	84 - M8 × 40	0.075

Skrūve DIN 7985 balti cinkota, PZ un PH



ARTIKULS	CENA	ARTIKULS	CENA	ARTIKULS	CENA
7985 - M3 × 10	0.007	7985 - M4 × 40	0.024	7985 - M6 × 12	0.028
7985 - M3 × 12	0.008	7985 - M4 × 50	0.028	7985 - M6 × 16	0.031
7985 - M3 × 16	0.008	7985 - M4 × 60	0.036	7985 - M6 × 20	0.034
7985 - M3 × 20	0.010	7985 - M5 × 10	0.018	7985 - M6 × 25	0.039
7985 - M3 × 25	0.012	7985 - M5 × 12	0.019	7985 - M6 × 30	0.049
7985 - M3 × 30	0.013	7985 - M5 × 16	0.020	7985 - M6 × 40	0.063
7985 - M4 × 10	0.011	7985 - M5 × 20	0.023	7985 - M6 × 50	0.070
7985 - M4 × 12	0.012	7985 - M5 × 25	0.025	7985 - M6 × 60	0.081
7985 - M4 × 16	0.013	7985 - M5 × 30	0.030	7985 - M8 × 20	0.079
7985 - M4 × 20	0.015	7985 - M5 × 40	0.037	7985 - M8 × 30	0.095
7985 - M4 × 25	0.017	7985 - M5 × 50	0.043	7985 - M8 × 40	0.125
7985 - M4 × 30	0.020	7985 - M5 × 60	0.060	7985 - M8 × 50	0.134
7985 - M4 × 35	0.022	7985 - M6 × 10	0.026	7985 - M8 × 60	0.142

Skrūve DIN 965 balti cinkota, PZ un PH



ARTIKULS	CENA	ARTIKULS	CENA	ARTIKULS	CENA
965 - M4 × 10	0.008	965 - M5 × 30	0.026	965 - M6 × 40	0.047
965 - M4 × 12	0.008	965 - M5 × 40	0.034	965 - M6 × 50	0.057
965 - M4 × 16	0.008	965 - M5 × 50	0.042	965 - M6 × 60	0.066
965 - M4 × 20	0.010	965 - M5 × 60	0.049	965 - M6 × 70	0.077
965 - M4 × 25	0.014	965 - M5 × 70	0.064	965 - M6 × 80	0.088
965 - M4 × 30	0.019	965 - M5 × 80	0.080	965 - M8 × 16	0.044
965 - M4 × 40	0.022	965 - M6 × 12	0.018	965 - M8 × 20	0.052
965 - M4 × 50	0.028	965 - M6 × 16	0.020	965 - M8 × 25	0.063
965 - M5 × 12	0.012	965 - M6 × 20	0.022	965 - M8 × 30	0.079
965 - M5 × 16	0.014	965 - M6 × 25	0.027	965 - M8 × 40	0.091
965 - M5 × 20	0.018	965 - M6 × 30	0.030	965 - M8 × 50	0.139
965 - M5 × 25	0.022	965 - M6 × 35	0.039	965 - M8 × 60	0.161

Bultskrūve DIN 912 8.8 balti cinkota, HEX

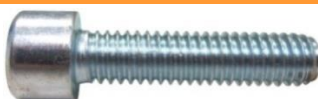

ARTIKULS	CENA	ARTIKULS	CENA	ARTIKULS	CENA
912 8.8 - M4 × 12	0.024	912 8.8 - M6 × 70	0.116	912 8.8 - M10 × 70	0.233
912 8.8 - M4 × 16	0.026	912 8.8 - M6 × 80	0.117	912 8.8 - M10 × 80	0.244
912 8.8 - M4 × 20	0.028	912 8.8 - M6 × 100	0.150	912 8.8 - M10 × 100	0.350
912 8.8 - M4 × 25	0.030	912 8.8 - M8 × 16	0.060	912 8.8 - M12 × 20	0.150
912 8.8 - M4 × 30	0.035	912 8.8 - M8 × 20	0.064	912 8.8 - M12 × 25	0.171
912 8.8 - M4 × 40	0.043	912 8.8 - M8 × 25	0.076	912 8.8 - M12 × 30	0.176
912 8.8 - M5 × 12	0.024	912 8.8 - M8 × 30	0.082	912 8.8 - M12 × 40	0.206
912 8.8 - M5 × 16	0.024	912 8.8 - M8 × 35	0.091	912 8.8 - M12 × 50	0.244
912 8.8 - M5 × 20	0.025	912 8.8 - M8 × 40	0.095	912 8.8 - M12 × 60	0.268
912 8.8 - M5 × 25	0.031	912 8.8 - M8 × 50	0.125	912 8.8 - M12 × 70	0.299
912 8.8 - M5 × 30	0.036	912 8.8 - M8 × 60	0.166	912 8.8 - M12 × 80	0.358
912 8.8 - M5 × 40	0.042	912 8.8 - M8 × 70	0.176	912 8.8 - M12 × 100	0.517
912 8.8 - M5 × 50	0.047	912 8.8 - M8 × 80	0.198	912 8.8 - M12 × 120	0.642
912 8.8 - M6 × 16	0.027	912 8.8 - M8 × 100	0.265	912 8.8 - M14 × 40	0.369
912 8.8 - M6 × 20	0.032	912 8.8 - M10 × 20	0.132	912 8.8 - M14 × 50	0.400
912 8.8 - M6 × 25	0.043	912 8.8 - M10 × 25	0.144	912 8.8 - M16 × 40	0.430
912 8.8 - M6 × 30	0.050	912 8.8 - M10 × 30	0.144	912 8.8 - M16 × 50	0.468
912 8.8 - M6 × 35	0.056	912 8.8 - M10 × 35	0.155	912 8.8 - M16 × 60	0.614
912 8.8 - M6 × 40	0.057	912 8.8 - M10 × 40	0.183	912 8.8 - M16 × 70	0.686
912 8.8 - M6 × 50	0.064	912 8.8 - M10 × 50	0.208	912 8.8 - M16 × 80	0.783
912 8.8 - M6 × 60	0.075	912 8.8 - M10 × 60	0.231	912 8.8 - M16 × 100	1.102

Bultskrūve DIN 912 12.9 melna, HEX



ARTIKULS	CENA	ARTIKULS	CENA	ARTIKULS	CENA
912 12.9 - M4 × 12	0.033	912 12.9 - M8 × 70	0.205	912 12.9 - M14 × 50	0.555
912 12.9 - M4 × 16	0.034	912 12.9 - M8 × 80	0.242	912 12.9 - M16 × 30	0.461
912 12.9 - M4 × 20	0.037	912 12.9 - M8 × 100	0.304	912 12.9 - M16 × 40	0.552
912 12.9 - M4 × 30	0.043	912 12.9 - M10 × 20	0.154	912 12.9 - M16 × 50	0.650
912 12.9 - M5 × 12	0.033	912 12.9 - M10 × 25	0.180	912 12.9 - M16 × 60	0.747
912 12.9 - M5 × 16	0.036	912 12.9 - M10 × 30	0.191	912 12.9 - M16 × 70	0.830
912 12.9 - M5 × 20	0.039	912 12.9 - M10 × 35	0.214	912 12.9 - M16 × 80	0.897
912 12.9 - M5 × 25	0.040	912 12.9 - M10 × 40	0.216	912 12.9 - M16 × 100	1.100
912 12.9 - M5 × 30	0.045	912 12.9 - M10 × 50	0.242	912 12.9 - M16 × 120	1.300
912 12.9 - M5 × 40	0.051	912 12.9 - M10 × 60	0.286	912 12.9 - M16 × 140	1.423
912 12.9 - M6 × 16	0.046	912 12.9 - M10 × 70	0.331	912 12.9 - M16 × 160	1.709
912 12.9 - M6 × 20	0.053	912 12.9 - M10 × 80	0.363	912 12.9 - M16 × 180	2.163
912 12.9 - M6 × 25	0.056	912 12.9 - M10 × 100	0.467	912 12.9 - M16 × 200	2.561
912 12.9 - M6 × 30	0.057	912 12.9 - M10 × 120	0.567	912 12.9 - M20 × 40	1.017
912 12.9 - M6 × 35	0.070	912 12.9 - M10 × 140	0.775	912 12.9 - M20 × 50	1.116
912 12.9 - M6 × 40	0.071	912 12.9 - M12 × 20	0.214	912 12.9 - M20 × 60	1.358
912 12.9 - M6 × 50	0.083	912 12.9 - M12 × 25	0.230	912 12.9 - M20 × 70	1.461
912 12.9 - M6 × 60	0.114	912 12.9 - M12 × 30	0.250	912 12.9 - M20 × 80	1.564
912 12.9 - M6 × 70	0.145	912 12.9 - M12 × 35	0.265	912 12.9 - M20 × 100	1.753
912 12.9 - M6 × 80	0.155	912 12.9 - M12 × 40	0.274	912 12.9 - M20 × 120	1.999
912 12.9 - M8 × 16	0.078	912 12.9 - M12 × 50	0.316	912 12.9 - M20 × 140	2.345
912 12.9 - M8 × 20	0.085	912 12.9 - M12 × 60	0.392	912 12.9 - M24 × 50	1.968
912 12.9 - M8 × 25	0.107	912 12.9 - M12 × 70	0.450	912 12.9 - M24 × 60	2.092
912 12.9 - M8 × 30	0.121	912 12.9 - M12 × 80	0.500	912 12.9 - M24 × 70	2.310
912 12.9 - M8 × 35	0.127	912 12.9 - M12 × 100	0.668	912 12.9 - M24 × 80	2.712
912 12.9 - M8 × 40	0.135	912 12.9 - M12 × 120	0.868	912 12.9 - M24 × 100	2.906
912 12.9 - M8 × 50	0.160	912 12.9 - M12 × 140	1.060	912 12.9 - M24 × 120	3.401
912 12.9 - M8 × 60	0.189	912 12.9 - M14 × 40	0.490	912 12.9 - M24 × 140	4.417

Skrūve DIN 603 4.6 balti cinkota



ARTIKULS	CENA	ARTIKULS	CENA
603 4.6 - M6 × 16	0.033	603 4.6 - M10 × 40	0.120
603 4.6 - M6 × 20	0.034	603 4.6 - M10 × 50	0.139
603 4.6 - M6 × 25	0.036	603 4.6 - M10 × 60	0.171
603 4.6 - M6 × 30	0.040	603 4.6 - M10 × 70	0.181
603 4.6 - M6 × 35	0.043	603 4.6 - M10 × 80	0.197
603 4.6 - M6 × 40	0.046	603 4.6 - M10 × 90	0.216
603 4.6 - M6 × 50	0.052	603 4.6 - M10 × 100	0.228
603 4.6 - M6 × 60	0.059	603 4.6 - M10 × 110	0.245
603 4.6 - M6 × 70	0.064	603 4.6 - M10 × 120	0.280
603 4.6 - M6 × 80	0.077	603 4.6 - M10 × 130	0.290
603 4.6 - M6 × 90	0.084	603 4.6 - M10 × 140	0.311
603 4.6 - M6 × 100	0.086	603 4.6 - M10 × 150	0.325
603 4.6 - M6 × 120	0.100	603 4.6 - M10 × 160	0.346
603 4.6 - M8 × 20	0.050	603 4.6 - M10 × 180	0.384
603 4.6 - M8 × 25	0.060	603 4.6 - M10 × 200	0.452
603 4.6 - M8 × 30	0.068	603 4.6 - M10 × 220	0.488
603 4.6 - M8 × 35	0.071	603 4.6 - M10 × 240	0.499
603 4.6 - M8 × 40	0.076	603 4.6 - M10 × 260	0.518
603 4.6 - M8 × 50	0.088	603 4.6 - M10 × 280	0.525
603 4.6 - M8 × 60	0.098	603 4.6 - M10 × 300	0.566
603 4.6 - M8 × 70	0.114	603 4.6 - M12 × 30	0.171
603 4.6 - M8 × 80	0.128	603 4.6 - M12 × 40	0.216
603 4.6 - M8 × 90	0.135	603 4.6 - M12 × 50	0.222
603 4.6 - M8 × 100	0.155	603 4.6 - M12 × 60	0.253
603 4.6 - M8 × 110	0.166	603 4.6 - M12 × 70	0.289
603 4.6 - M8 × 120	0.184	603 4.6 - M12 × 80	0.326
603 4.6 - M8 × 130	0.203	603 4.6 - M12 × 90	0.339
603 4.6 - M8 × 140	0.225	603 4.6 - M12 × 100	0.367
603 4.6 - M8 × 150	0.239	603 4.6 - M12 × 120	0.416
603 4.6 - M8 × 160	0.285	603 4.6 - M12 × 140	0.492
603 4.6 - M8 × 180	0.346	603 4.6 - M12 × 160	0.543
603 4.6 - M8 × 200	0.363	603 4.6 - M12 × 180	0.577
603 4.6 - M10 × 25	0.098	603 4.6 - M12 × 200	0.626
603 4.6 - M10 × 30	0.100	603 4.6 - M12 × 240	0.851

Skrūve mēbeļu rokturiem balti cinkota, PZ2

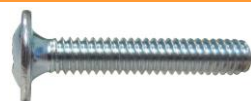

ARTIKULS	CENA
RS - M4 × 10	0.018
RS - M4 × 20	0.018
RS - M4 × 22	0.021
RS - M4 × 25	0.022
RS - M4 × 30	0.024
RS - M4 × 35	0.024
RS - M4 × 40	0.028
RS - M4 × 45	0.033
RS - M4 × 50	0.036

Mēbeļu skrūve ar metrisku vītņi dzelteni cinkota, 4mm HEX



ARTIKULS	CENA
MS - M6 × 20	0.060
MS - M6 × 30	0.070
MS - M6 × 40	0.090
MS - M6 × 50	0.100
MS - M6 × 60	0.130
MS - M6 × 70	0.140
MS - M6 × 80	0.160
MS - M6 × 90	0.160
MS - M6 × 100	0.170
MS - M6 × 110	0.190

Mēbeļu skrūve ar rupjo vītņi dzelteni cinkota, 4mm HEX



ARTIKULS	CENA
MS - 6.3 × 30	0.090
MS - 6.3 × 40	0.100
MS - 6.3 × 50	0.120
MS - 6.3 × 60	0.130
MS - 6.3 × 70	0.160
MS - 6.3 × 80	0.170
MS - 6.3 × 90	0.180
MS - 6.3 × 100	0.190
MS - 6.3 × 110	0.200

Mēbeļu uzgrieznis SPEC 2 dzelteni cinkots. 4mm HEX



ARTIKULS	CENA
s2 - M6	0.110

Mēbeļu uzgrieznis ar fiksējošām šķautnēm SPEC 7 balti cinkots



ARTIKULS	CENA
s7 - M4	0.040
s7 - M5	0.050
s7 - M6	0.060
s7 - M8	0.070
s7 - M10	0.130

Skrūve kokam SPEC 18 A2 (nerūs. tērauds), PZ gremdgalva



ARTIKULS	CENA	ARTIKULS	CENA
s18 A2 - 3 × 16	0.014	s18 A2 - 4.5 × 50	0.054
s18 A2 - 3 × 20	0.016	s18 A2 - 4.5 × 60	0.060
s18 A2 - 3 × 25	0.017	s18 A2 - 4.5 × 70	0.070
s18 A2 - 3 × 30	0.019	s18 A2 - 5 × 40	0.057
s18 A2 - 3 × 40	0.024	s18 A2 - 5 × 50	0.064
s18 A2 - 3.5 × 20	0.018	s18 A2 - 5 × 60	0.070
s18 A2 - 3.5 × 25	0.021	s18 A2 - 5 × 70	0.084
s18 A2 - 3.5 × 30	0.025	s18 A2 - 5 × 80	0.095
s18 A2 - 3.5 × 40	0.030	s18 A2 - 5 × 90	0.105
s18 A2 - 3.5 × 50	0.034	s18 A2 - 5 × 100	0.128
s18 A2 - 4 × 20	0.021	s18 A2 - 6 × 40	0.082
s18 A2 - 4 × 25	0.025	s18 A2 - 6 × 50	0.100
s18 A2 - 4 × 30	0.028	s18 A2 - 6 × 60	0.114
s18 A2 - 4 × 35	0.034	s18 A2 - 6 × 70	0.129
s18 A2 - 4 × 40	0.037	s18 A2 - 6 × 80	0.154
s18 A2 - 4 × 50	0.045	s18 A2 - 6 × 100	0.207
s18 A2 - 4 × 60	0.055	s18 A2 - 6 × 120	0.240
s18 A2 - 4.5 × 40	0.045		

Skrūve kokam A2 (nerūs. tērauds), TORX gremdgalva



ARTIKULS	CENA
TX A2 - 4 × 20	0.021
TX A2 - 4 × 25	0.025
TX A2 - 4 × 30	0.028
TX A2 - 4 × 35	0.034
TX A2 - 4 × 40	0.037
TX A2 - 4 × 50	0.045
TX A2 - 4 × 60	0.055
TX A2 - 4 × 70	0.065
TX A2 - 4.5 × 30	0.034
TX A2 - 4.5 × 35	0.040
TX A2 - 4.5 × 40	0.045
TX A2 - 4.5 × 50	0.054
TX A2 - 4.5 × 60	0.060
TX A2 - 4.5 × 70	0.070
TX A2 - 5 × 50	0.064
TX A2 - 5 × 60	0.070
TX A2 - 5 × 70	0.084
TX A2 - 5 × 80	0.095
TX A2 - 5 × 90	0.105
TX A2 - 5 × 100	0.128
TX A2 - 6 × 40	0.082
TX A2 - 6 × 50	0.100
TX A2 - 6 × 60	0.114
TX A2 - 6 × 70	0.129
TX A2 - 6 × 80	0.154
TX A2 - 6 × 90	0.181
TX A2 - 6 × 100	0.207
TX A2 - 6 × 120	0.240
TX A2 - 6 × 140	0.278

Terašu skrūve AISI410+ (nerūs. tērauds) RUSPERT zaļa, TORX T20 pašņēnķējošā gremdgalva



ARTIKULS	CENA
TER AISI410 RSPza - 4.2 × 45	0.045
TER AISI410 RSPza - 4.2 × 55	0.050

Terašu skrūve AISI410+ (nerūs. tērauds) RUSPERT brūna, TORX T20 pašņēnķējošā gremdgalva



ARTIKULS	CENA
TER AISI410 RSPbr - 4.2 × 45	0.045
TER AISI410 RSPbr - 4.2 × 55	0.050
TER AISI410 RSPbr - 4.8 × 70	0.080
TER AISI410 RSPbr - 4.8 × 90	0.099

Terašu skrūve AISI410+ (nerūs. tērauds) RUSPERT sudraba, TORX T20 pašņēnķējošā gremdgalva



ARTIKULS	CENA
TER AISI410 RSP - 4.2 × 45	0.045
TER AISI410 RSP - 4.2 × 55	0.050

Terašu skrūve A4 (nerūs. tērauds), TORX T20 gremdgalva





ARTIKULS	CENA
TER TX A4 - 4.5 × 55	0.100
TER TX A4 - 4.5 × 75	0.120
TER TX A4 - 4.5 × 90	0.140

Montāžas skrūve SPEC 23 AISI410+ (nerūs. tērauds) RUSPERT, PH2





ARTIKULS	CENA
s23 AISI410 RSP - 4.2 × 13	0.051
s23 AISI410 RSP - 4.2 × 19	0.056
s23 AISI410 RSP - 4.2 × 25	0.060

Kontruzgrieznis DIN 985 A2 (nerūs. tērauds)	
	
ARTIKULS	CENA
985 A2 - M4	0.019
985 A2 - M5	0.024
985 A2 - M6	0.037
985 A2 - M8	0.068
985 A2 - M10	0.139
985 A2 - M12	0.209
985 A2 - M16	0.495

Kausuzgrieznis DIN 1587 A2 (nerūs. tērauds)	
	
ARTIKULS	CENA
1587 A2 - M6	0.100
1587 A2 - M8	0.180
1587 A2 - M10	0.320
1587 A2 - M12	0.490
1587 A2 - M16	1.100

Spārnuzgrieznis DIN 315 A2 (nerūs. tērauds)	
	
ARTIKULS	CENA
315 A2 - M6	0.150
315 A2 - M8	0.270
315 A2 - M10	0.380
315 A2 - M12	0.760

Kniede DIN 7337 A2/A2 (nerūs. tērauds)	
	
ARTIKULS	CENA
7337 A2/A2 - 3.2 × 6	0.030
7337 A2/A2 - 3.2 × 8	0.032
7337 A2/A2 - 3.2 × 10	0.036
7337 A2/A2 - 3.2 × 12	0.040
7337 A2/A2 - 4.0 × 8	0.048
7337 A2/A2 - 4.0 × 10	0.049
7337 A2/A2 - 4.0 × 12	0.052
7337 A2/A2 - 4.0 × 14	0.057
7337 A2/A2 - 4.8 × 8	0.060
7337 A2/A2 - 4.8 × 10	0.073
7337 A2/A2 - 4.8 × 12	0.084
7337 A2/A2 - 4.8 × 14	0.089
7337 A2/A2 - 4.8 × 16	0.104
7337 A2/A2 - 4.8 × 18	0.112

Uzgrieznis DIN 934 A2 (nerūs. tērauds)	
	
ARTIKULS	CENA
934 A2 - M3	0.016
934 A2 - M4	0.016
934 A2 - M5	0.017
934 A2 - M6	0.026
934 A2 - M8	0.043
934 A2 - M10	0.116
934 A2 - M12	0.185
934 A2 - M14	0.302
934 A2 - M16	0.322
934 A2 - M20	0.626
934 A2 - M24	1.025



Paplāksne DIN 125 A2 (nerūs. tērauds)	
	
ARTIKULS	CENA
125 A2 - M3	0.005
125 A2 - M4	0.006
125 A2 - M5	0.007
125 A2 - M6	0.013
125 A2 - M8	0.021
125 A2 - M10	0.040
125 A2 - M12	0.074
125 A2 - M16	0.128
125 A2 - M20	0.160
125 A2 - M24	0.242

Paplātinātā paplāksne DIN 9021 A2 (nerūs. tērauds)	
	
ARTIKULS	CENA
9021 A2 - M4	0.009
9021 A2 - M5	0.015
9021 A2 - M6	0.033
9021 A2 - M8	0.065
9021 A2 - M10	0.118
9021 A2 - M12	0.202
9021 A2 - M16	0.362



Atsperpaplāksne DIN 127 A2 (nerūs. tērauds)	
	
ARTIKULS	CENA
127 A2 - M4	0.008
127 A2 - M5	0.009
127 A2 - M6	0.013
127 A2 - M8	0.021
127 A2 - M10	0.037
127 A2 - M12	0.062
127 A2 - M16	0.096



Paplāksne ar gumiju SPEC 15 A2 (nerūs. tērauds)	
	
ARTIKULS	CENA
s15 A2 - 14/5.1mm	0.030
s15 A2 - 16/6.8mm	0.039

Skrūve ISO 7380 A2 (nerūs. tērauds), HEX	
	
ARTIKULS	CENA
i7380 A2 - M4 × 20	0.038
i7380 A2 - M5 × 12	0.034
i7380 A2 - M5 × 16	0.038
i7380 A2 - M5 × 20	0.041
i7380 A2 - M6 × 12	0.042
i7380 A2 - M6 × 16	0.048
i7380 A2 - M6 × 20	0.060
i7380 A2 - M6 × 25	0.069
i7380 A2 - M6 × 30	0.077
i7380 A2 - M8 × 16	0.102
i7380 A2 - M8 × 20	0.112
i7380 A2 - M8 × 30	0.140
i7380 A2 - M10 × 20	0.201

Skrūve DIN 912 A2 (nerūs. tērauds), HEX	
	
ARTIKULS	CENA
912 A2 - M6 × 16	0.061
912 A2 - M6 × 20	0.071
912 A2 - M6 × 25	0.085
912 A2 - M6 × 30	0.090
912 A2 - M8 × 16	0.122
912 A2 - M8 × 20	0.142
912 A2 - M8 × 25	0.170
912 A2 - M8 × 30	0.190
912 A2 - M10 × 20	0.246
912 A2 - M10 × 30	0.313
912 A2 - M10 × 40	0.376

Skrūve DIN 7991 A2 (nerūs. tērauds), HEX	
	
ARTIKULS	CENA
7991 A2 - M6 × 16	0.054
7991 A2 - M6 × 20	0.064
7991 A2 - M6 × 30	0.077
7991 A2 - M6 × 40	0.104
7991 A2 - M8 × 16	0.087
7991 A2 - M8 × 20	0.104
7991 A2 - M8 × 30	0.150
7991 A2 - M8 × 40	0.197
7991 A2 - M8 × 50	0.243
7991 A2 - M10 × 20	0.205
7991 A2 - M10 × 30	0.270
7991 A2 - M10 × 40	0.331
7991 A2 - M10 × 50	0.437
7991 A2 - M10 × 60	0.520
7991 A2 - M12 × 30	0.400

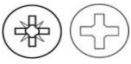
Skrūve DIN 7985 A2 (nerūs. tērauds), PZ un PH	
	
ARTIKULS	CENA
7985 A2 - M3 × 16	0.026
7985 A2 - M4 × 10	0.035
7985 A2 - M4 × 16	0.044
7985 A2 - M4 × 20	0.048
7985 A2 - M4 × 30	0.065
7985 A2 - M5 × 16	0.055
7985 A2 - M5 × 20	0.068
7985 A2 - M5 × 30	0.090
7985 A2 - M5 × 40	0.097
7985 A2 - M6 × 16	0.100
7985 A2 - M6 × 20	0.107
7985 A2 - M6 × 25	0.114
7985 A2 - M6 × 30	0.114
7985 A2 - M6 × 40	0.139
7985 A2 - M6 × 50	0.148
7985 A2 - M8 × 25	0.199

Skrūve DIN 965 A2 (nerūs. tērauds), PZ un PH	
	
ARTIKULS	CENA
965 A2 - M3 × 12	0.014
965 A2 - M3 × 16	0.018
965 A2 - M3 × 20	0.019
965 A2 - M4 × 12	0.020
965 A2 - M4 × 16	0.026
965 A2 - M4 × 20	0.032
965 A2 - M4 × 30	0.048
965 A2 - M4 × 40	0.064
965 A2 - M5 × 12	0.033
965 A2 - M5 × 16	0.036
965 A2 - M5 × 20	0.043
965 A2 - M5 × 30	0.063
965 A2 - M5 × 40	0.080
965 A2 - M5 × 50	0.099
965 A2 - M6 × 16	0.062
965 A2 - M6 × 20	0.071
965 A2 - M6 × 30	0.087
965 A2 - M6 × 40	0.107
965 A2 - M6 × 50	0.148
965 A2 - M8 × 16	0.099

Troše AISI316 (nerūs. tērauds)	
	
ARTIKULS	CENA
T(7×7) AISI316 - 1.0mm	0.180
T(7×7) AISI316 - 2.0mm	0.370
T(7×19) AISI316 - 3.0mm	0.850

Vītņstienis DIN 975 A2 (nerūs. tērauds)



ARTIKULS	CENA	ARTIKULS	CENA
975 A2 - M5 × 1000	1.520	975 A2 - M6 × 2000	3.320
975 A2 - M6 × 1000	1.660	975 A2 - M8 × 2000	5.080
975 A2 - M8 × 1000	2.540	975 A2 - M10 × 2000	7.780
975 A2 - M10 × 1000	3.890	975 A2 - M12 × 2000	11.320
975 A2 - M12 × 1000	5.660	975 A2 - M16 × 2000	18.360
975 A2 - M16 × 1000	9.180	975 A2 - M20 × 2000	27.800
		975 A2 - M24 × 2000	37.900

Bultskrūve ar seškantu galvu DIN 933 (pilna vītne) A2 (nerūs. tērauds)



ARTIKULS	CENA	ARTIKULS	CENA
933 A2 - M5 × 16	0.050	933 A2 - M10 × 25	0.249
933 A2 - M5 × 20	0.054	933 A2 - M10 × 30	0.262
933 A2 - M5 × 30	0.063	933 A2 - M10 × 35	0.285
933 A2 - M6 × 12	0.053	933 A2 - M10 × 40	0.314
933 A2 - M6 × 16	0.054	933 A2 - M10 × 50	0.371
933 A2 - M6 × 20	0.063	933 A2 - M10 × 60	0.398
933 A2 - M6 × 25	0.072	933 A2 - M10 × 70	0.440
933 A2 - M6 × 30	0.078	933 A2 - M10 × 80	0.486
933 A2 - M6 × 40	0.092	933 A2 - M12 × 25	0.342
933 A2 - M6 × 50	0.115	933 A2 - M12 × 30	0.360
933 A2 - M6 × 60	0.135	933 A2 - M12 × 35	0.406
933 A2 - M8 × 16	0.110	933 A2 - M12 × 40	0.455
933 A2 - M8 × 20	0.127	933 A2 - M12 × 50	0.520
933 A2 - M8 × 25	0.134	933 A2 - M12 × 60	0.561
933 A2 - M8 × 30	0.156	933 A2 - M12 × 70	0.655
933 A2 - M8 × 35	0.165	933 A2 - M12 × 80	0.716
933 A2 - M8 × 40	0.187	933 A2 - M16 × 30	0.835
933 A2 - M8 × 50	0.212	933 A2 - M16 × 40	0.913
933 A2 - M8 × 60	0.241	933 A2 - M16 × 50	1.032
933 A2 - M8 × 70	0.313	933 A2 - M16 × 60	1.213
933 A2 - M8 × 80	0.342	933 A2 - M16 × 70	1.325
933 A2 - M10 × 20	0.242	933 A2 - M16 × 80	1.449

Pašgriezoša skrūve DIN 7981 A2 (nerūs. tērauds), PZ



ARTIKULS	CENA
7981 A2 - 3.5 × 13	0.016
7981 A2 - 3.5 × 16	0.017
7981 A2 - 3.5 × 19	0.018
7981 A2 - 3.5 × 25	0.024
7981 A2 - 4.2 × 13	0.024
7981 A2 - 4.2 × 16	0.029
7981 A2 - 4.2 × 19	0.031
7981 A2 - 4.2 × 25	0.035
7981 A2 - 4.8 × 16	0.032
7981 A2 - 4.8 × 19	0.037
7981 A2 - 4.8 × 25	0.041
7981 A2 - 4.8 × 32	0.045
7981 A2 - 5.5 × 16	0.048
7981 A2 - 5.5 × 19	0.056
7981 A2 - 5.5 × 25	0.063
7981 A2 - 5.5 × 32	0.074
7981 A2 - 6.3 × 19	0.069
7981 A2 - 6.3 × 25	0.075
7981 A2 - 6.3 × 32	0.097

Pašgriezoša skrūve DIN 7982 A2 (nerūs. tērauds), PZ



ARTIKULS	CENA
7982 A2 - 3.5 × 13	0.017
7982 A2 - 3.5 × 16	0.022
7982 A2 - 3.5 × 19	0.024
7982 A2 - 3.5 × 25	0.027
7982 A2 - 4.2 × 13	0.019
7982 A2 - 4.2 × 16	0.021
7982 A2 - 4.2 × 19	0.024
7982 A2 - 4.2 × 25	0.030
7982 A2 - 4.8 × 16	0.031
7982 A2 - 4.8 × 19	0.037
7982 A2 - 4.8 × 25	0.046

Bultskrūve ar seškantu galvu DIN 931 (nepilna vītne) A2 (nerūs. tērauds)



ARTIKULS	CENA	ARTIKULS	CENA
931 A2 - M6 × 60	0.135	931 A2 - M12 × 90	0.881
931 A2 - M6 × 70	0.190	931 A2 - M12 × 100	0.988
931 A2 - M8 × 90	0.396	931 A2 - M12 × 120	1.150
931 A2 - M8 × 100	0.448	931 A2 - M16 × 90	1.467
931 A2 - M10 × 90	0.633	931 A2 - M16 × 100	1.791
931 A2 - M10 × 100	0.691	931 A2 - M16 × 120	2.098
931 A2 - M10 × 120	0.880	931 A2 - M16 × 140	2.288

Pašgriezoša skrūve DIN 7983 A2 (nerūs. tērauds), PZ



ARTIKULS	CENA
7983 A2 - 3.5 × 13	0.017
7983 A2 - 3.5 × 16	0.022
7983 A2 - 3.5 × 19	0.024
7983 A2 - 3.5 × 25	0.027
7983 A2 - 4.8 × 16	0.031
7983 A2 - 4.8 × 19	0.037
7983 A2 - 4.8 × 25	0.046

STIPRINĀJUMI

Dībeļi	27
Dībeļnaglas, skrūves	28
Enkurmasas	29
Ķīļenkuri, skrūves betonam	30
Enkuri	31
Ģipškartona stiprinājumi	32
Siltumizolācijas stiprinājumi	33
Naglas	34
Kniedes, kniežu stangas	35
Skavas, skavu pistoles	36
Leņķi	37
Būvkalumi, montāžas lentas	38
Ķēdes, troses, virves, stiprinājumi	39
Kravu stiprinājumi	41

Dībeļa izmērs - Skrūves izmērs

4mm - M2-3
 5mm - M2.5-4
 6mm - M3.5-5
 8mm - M4.5-6
 10mm - M6-8
 12mm - M8-10
 14mm - M10-12
 16mm - M12-14
 20mm - M14-16

Neilona dībelis ar pagarinātu izplešanās zonu MUNGO MB

Stiprināms: pilnais un caurumotais ķieģelis, gāzbetons, smilšakmens



ARTIKULS	CENA
MB - 10 × 80	0.151
MB - 10 × 100	0.221
MB - 10 × 120	0.245
MB - 10 × 140	0.270
MB - 10 × 160	0.313
MB - 10 × 200	0.390

Universālais neilona dībelis MUNGO MU

Stiprināms: betons, pilnais un caurumotais ķieģelis, gāzbetons, ģipškartons, saplāksnis



ARTIKULS	CENA
MU - 6 × 35	0.040
MU - 6 × 45	0.050
MU - 8 × 50	0.060
MU - 10 × 60	0.110
MU - 12 × 70	0.185

Universālais neilona dībelis SORMAT GRIPPER

Stiprināms: betons, pilnais un caurumotais ķieģelis, gāzbetons, ģipškartons, saplāksnis

SORMAT



ARTIKULS	CENA
GRIPPER - 5 × 24	0.115
GRIPPER - 6 × 32	0.147
GRIPPER - 8 × 38	0.200
GRIPPER - 10 × 45	0.440

Neilona dībelis MUNGO MBR

Stiprināms: betons, pilnais ķieģelis
 Iegremdējams dziļums: 50mm



ARTIKULS	CENA
MBR - 6 × 55	0.063
MBR - 8 × 80	0.090
MBR - 8 × 100	0.141
MBR - 8 × 120	0.158
MBR - 8 × 140	0.175
MBR - 10 × 60	0.135
MBR - 10 × 80	0.158
MBR - 10 × 100	0.176
MBR - 10 × 120	0.199
MBR - 10 × 140	0.222
MBR - 10 × 160	0.242

Neilona dībelis MUNGO MN

Stiprināms: cements, pilnais ķieģelis, gāzbetons, akmens, ģipsis



ARTIKULS	CENA
MN - 4 × 20	0.016
MN - 5 × 25	0.016
MN - 6 × 30	0.022
MN - 8 × 40	0.036
MN - 10 × 50	0.071
MN - 12 × 60	0.107
MN - 14 × 70	0.194
MN - 16 × 80	0.342
MN - 20 × 90	0.580

Neilona dībelis SORMAT NAT

Stiprināms: betons, pilnais ķieģelis, gāzbetons, akmens, ģipsis

SORMAT



ARTIKULS	CENA
NAT - 5 × 25	0.014
NAT - 6 × 30	0.015
NAT - 8 × 40	0.026
NAT L - 8 × 65	0.066
NAT - 10 × 50	0.049
NAT L - 10 × 80	0.099
NAT - 12 × 60	0.099

Neilona dībelis MUNGO ML

Stiprināms: betons, gāzbetons, pilnais un caurumotais ķieģelis, ģipsis



ARTIKULS	CENA
ML - 6 × 60	0.063
ML - 8 × 80	0.090
ML - 10 × 90	0.192
ML - 10 × 120	0.249
ML - 14 × 90	0.369
ML - 14 × 120	0.430

Neilona dībelis MUNGO MGD

Stiprināms: betons, pilnais un caurumotais ķieģelis, akmens



ARTIKULS	CENA
MGD - 14 × 70	0.159
MGD - 14 × 100	0.195
MGD - 14 × 140	0.240

Polipropilēna dībelis KOELNER

ARTIKULS	CENA
FIX-K - 5 × 25	0.010
FIX-K - 6 × 30	0.012
FIX-K - 8 × 40	0.016
FIX-K - 10 × 50	0.030
FIX-K - 12 × 60	0.057
FIX-K - 14 × 70	0.082



Universālais neilona dībelis SORMAT YLT

Stiprināms: betons, pilnais un caurumotais ķieģelis, gāzbetons, ģipškartons, saplāksnis



SORMAT



ARTIKULS	CENA
YLT - 6 × 30	0.030
YLT - 8 × 50	0.050
YLT - 10 × 60	0.100

Dībeļnagla ar gremdgalvu SM	
	
	
ARTIKULS	CENA
SM - 5 × 45	0.020
SM - 6 × 40	0.020
SM - 6 × 50	0.030
SM - 6 × 60	0.030
SM - 6 × 80	0.040
SM - 8 × 45	0.040
SM - 8 × 60	0.050
SM - 8 × 80	0.060
SM - 8 × 100	0.080
SM - 8 × 120	0.090
SM - 8 × 140	0.110
SM - 8 × 160	0.120
SM - 10 × 80	0.130
SM - 10 × 100	0.150
SM - 10 × 120	0.190
SM - 10 × 140	0.210
SM - 10 × 160	0.240
SM - 10 × 180	0.280
SM - 10 × 200	0.300

Metāla dībeļnagla	
	
ARTIKULS	CENA
MDN - 6 × 30	0.100
MDN - 6 × 40	0.140
MDN - 6 × 50	0.160
MDN - 6 × 65	0.190

Neilona dībeļnagla LYT LK	
	
	
ARTIKULS	CENA
LYT LK - 6 × 40	0.070
LYT LK - 6 × 60	0.080
LYT LK - 6 × 80	0.090
LYT LK - 8 × 60	0.110
LYT LK - 8 × 80	0.140
LYT LK - 8 × 100	0.160



Neilona dībelis ar skrūvi KPR-FAST K, seškantu galva	
	
	
ARTIKULS	CENA
KPR-FAST K - 10 × 80	0.230
KPR-FAST K - 10 × 100	0.310
KPR-FAST K - 10 × 120	0.390
KPR-FAST K - 10 × 140	0.440
KPR-FAST K - 10 × 160	0.520
KPR-FAST K - 10 × 180	0.570
KPR-FAST K - 10 × 200	0.650
KPR-FAST K - 10 × 230	1.440
KPR-FAST K - 10 × 260	1.580
KPR-FAST K - 10 × 300	1.990

Jumta izolācijas dībelis	
	
	
ARTIKULS	CENA
LINO - 35	0.050
LINO - 55	0.060
LINO - 85	0.070
LINO - 105	0.080
LINO - 135	0.090
LINO - 155	0.110
LINO - 185	0.120
LINO - 235	0.150
LINO - 285	0.180

Dībeļnagla ar paplatinātu galvu SMK	
	
	
ARTIKULS	CENA
SMK - 6 × 40	0.020
SMK - 6 × 60	0.030
SMK - 6 × 80	0.040

Skrūve jumta izolācijas dībelim ar urbi (metāls <2mm) cinkota	
	
ARTIKULS	CENA
SJDU - 4.8 × 60	0.050
SJDU - 4.8 × 80	0.069
SJDU - 4.8 × 100	0.099
SJDU - 4.8 × 120	0.167
SJDU - 4.8 × 140	0.195
SJDU - 4.8 × 160	0.223

Neilona dībelis MUNGO MB ar skrūvi, PZ3 gremdgalva	
	
ARTIKULS	CENA
MB-S - 10 × 100	0.480
MB-S - 10 × 140	0.620
MB-S - 10 × 200	1.060

Neilona dībelis ar skrūvi KPR-PIKE ST, TORX T30 gremdgalva	
	
	
ARTIKULS	CENA
KPR-PIKE ST - 8 × 65	0.100
KPR-PIKE ST - 8 × 80	0.130
KPR-PIKE ST - 8 × 100	0.140
KPR-PIKE ST - 8 × 120	0.180

Cilpskrūve ar dībeli HOX	
	
	
ARTIKULS	CENA
HOX - 12 × 160	1.290
HOX - 12 × 190	1.450
HOX - 12 × 230	1.620
HOX - 12 × 300	1.990
HOX - 12 × 350	2.100

Neilona dībelis ar skrūvi KPR-PIKE K, seškantu galva	
	
	
ARTIKULS	CENA
KPR-PIKE K - 8 × 65	0.110
KPR-PIKE K - 8 × 80	0.130
KPR-PIKE K - 8 × 100	0.150
KPR-PIKE K - 8 × 120	0.180

Skrūve jumta izolācijas dībelim cinkota	
	
ARTIKULS	CENA
SJD - 4.8 × 80	0.059
SJD - 4.8 × 100	0.101
SJD - 4.8 × 120	0.123
SJD - 4.8 × 140	0.150
SJD - 4.8 × 160	0.214

Uzgalis ar cilpu balti cinkots



ARTIKULS	CENA
171430 - M8	0.170
171431 - M10	0.330

Ķīmiskā kapsula KEM-VE

Materiāla temperatūra:
Vītņstienis:

Materiāls: Nesaplaisājais betons,
akmens

SORMAT 



ARTIKULS	CENA
KEM-VE - M10	1.000
KEM-VE - M12	1.100
KEM-VE - M16	1.240
KEM-VE - M20	2.830
KEM-VE - M24	3.360

Plastmasas dībelis mastikai



ARTIKULS	CENA
170531 - M6-M8 12 × 50	0.400
170532 - M10-M12 15 × 85	0.270
170534 - M16 20 × 85	0.390

Rokas pumpis caurumu tīrīšanai IPUM

SORMAT 



ARTIKULS	CENA
173780 - IPUM	24.980

Uzgaļa pagarinātājs ISL EXT 250mm

SORMAT 



ARTIKULS	CENA
170508 - ISL EXT	0.700

Enkurmasa SORMAT ITH 300 VE 300ml (-10...+40°C) + 2 uzgaļi

Materiāla temperatūra: -10...+40
Vītņstienis: M8-M30
Armatūra: 12-32mm

Materiāls: Saplaisājais un nesaplaisājais betons, gāzbetons, keramzīts, akmens, ķieģelis

SORMAT 



ARTIKULS	CENA
170546 - ITH 300 VE	13.600

Enkurmasa SORMAT ITH 300 WI 300ml (-20...+20°C) + 2 uzgaļi

Materiāla temperatūra: -20...+20
Vītņstienis: M8-M30
Armatūra: 12-32mm

Materiāls: Saplaisājais un nesaplaisājais betons, gāzbetons, keramzīts, akmens, ķieģelis

SORMAT 



ARTIKULS	CENA
170547 - ITH 300 WI	18.100

Metāla birste caurumu tīrīšanai



ARTIKULS	CENA
173785 - 13×300mm	1.900
173786 - 18×300mm	1.900
173787 - 28×300mm	1.900

Enkurmasa RAWLPLUG R-KEM II 300ml (-5...+30°C) + 2 uzgaļi

Materiāla temperatūra: -5...+30
Vītņstienis: M8-M24

Materiāls: Nesaplaisājais betons, akmens

RAWLPLUG 



ARTIKULS	CENA
170500 - R-KEM II 300ml	8.000

Enkurmasa INDEX MOPOSE 300ml (-5...+30°C) + 2 uzgaļi

Materiāla temperatūra: -5...+30
Vītņstienis: M8-M24

Materiāls: Nesaplaisājais betons, gāzbetons, keramzīts, akmens, ķieģelis

INDEX 



ARTIKULS	CENA
170491 - MOPOSE 300ml	10.000

Pistole IPU 150/300

SORMAT 



ARTIKULS	CENA
170515 - IPU 150/300	18.990

Uzgalis mastikai ISL

SORMAT 





ARTIKULS	CENA
170507 - ISL	1.100

Kļienkurs INDEX SPEC 35 balti cinkots	
	
ARTIKULS	CENA
MTH - 8 × 60	0.290
MTH - 8 × 75	0.300
MTH - 8 × 90	0.340
MTH - 8 × 115	0.410
MTH - 8 × 130	0.520
MTH - 8 × 155	0.540
MTH - 10 × 70	0.380
MTH - 10 × 90	0.470
MTH - 10 × 120	0.580
MTH - 10 × 150	0.660
MTH - 10 × 170	0.760
MTH - 10 × 210	1.060
MTH - 10 × 230	1.120
MTH - 12 × 90	0.680
MTH - 12 × 110	0.760
MTH - 12 × 140	0.880
MTH - 12 × 160	0.990
MTH - 12 × 180	1.170
MTH - 12 × 220	1.470
MTH - 12 × 250	1.700
MTA - 16 × 90	1.310
MTH - 16 × 125	1.410
MTH - 16 × 145	1.610
MTH - 16 × 170	1.800
MTH - 16 × 220	2.300
MTH - 16 × 250	2.830
MTH - 20 × 120	2.170
MTH - 20 × 170	2.810
MTH - 20 × 220	3.410
MTH - 20 × 270	4.290

Čaulenkurs ar vītņstieni un uzgriezni balti cinkots	
	
ARTIKULS	CENA
CH-ES - 8 × 45	0.220
CH-ES - 10 × 60	0.370
CH-ES - 10 × 80	0.420
CH-ES - 12 × 70	0.600
CH-ES - 12 × 100	0.760

Enkurs ar cilpskrūvi balti cinkots	
	
ARTIKULS	CENA
CH-AR - 8 × 45	0.290
CH-AR - 10 × 60	0.500
CH-AR - 12 × 70	0.900

Kļienkurs SORMAT S-KA balti cinkots	
	
ARTIKULS	CENA
S-KA - 6 × 40	0.250
S-KA - 6 × 65	0.360
S-KA - 6 × 100	0.490
S-KA - 8 × 52	0.280
S-KA - 8 × 72	0.360
S-KA - 8 × 92	0.410
S-KA - 8 × 112	0.450
S-KA - 8 × 147	0.580
S-KA - 10 × 62	0.450
S-KA - 10 × 92	0.520
S-KA - 10 × 112	0.600
S-KA - 10 × 132	0.730
S-KA - 10 × 162	1.180
S-KA - 12 × 103	0.740
S-KA - 12 × 128	0.830
S-KA - 12 × 148	1.160
S-KA - 12 × 178	1.440
S-KA - 12 × 253	3.230
S-KA - 16 × 90	1.780
S-KA - 16 × 123	1.880
S-KA - 16 × 138	2.040
S-KA - 16 × 168	2.220
S-KA - 16 × 213	3.460
S-KA - 20 × 170	4.350
S-KA - 20 × 220	4.750
S-KA - 20 × 280	5.800

Čaulenkurs ar bulkskrūvi balti cinkots	
	
ARTIKULS	CENA
CH-TO - 8 × 45	0.200
CH-TO - 8 × 60	0.220
CH-TO - 10 × 60	0.300
CH-TO - 10 × 80	0.380
CH-TO - 12 × 70	0.490
CH-TO - 12 × 100	0.600
CH-TO - 16 × 80	0.950
CH-TO - 16 × 110	1.160
CH-TO - 20 × 110	2.210

Enkurs ar āķskrūvi balti cinkots	
	
ARTIKULS	CENA
CH-GA - 8 × 45	0.290
CH-GA - 10 × 60	0.500
CH-GA - 12 × 70	0.810

Skrūve betonam FIXCON balti cinkota, seškantu galva ar TORX	
	
ARTIKULS	CENA
FIXCON - 6 × 35 Ø5mm	0.072
FIXCON - 6 × 50 Ø5mm	0.093
FIXCON - 6 × 80 Ø5mm	0.148
FIXCON - 7.5 × 40 Ø6mm	0.177
FIXCON - 7.5 × 50 Ø6mm	0.206
FIXCON - 7.5 × 60 Ø6mm	0.224
FIXCON - 7.5 × 80 Ø6mm	0.247
FIXCON - 7.5 × 100 Ø6mm	0.361
FIXCON - 7.5 × 120 Ø6mm	0.437
FIXCON - 10 × 60 Ø8mm	0.368
FIXCON - 10 × 80 Ø8mm	0.383
FIXCON - 10 × 100 Ø8mm	0.527
FIXCON - 10 × 120 Ø8mm	0.659

Skrūve betonam FIXCON C balti cinkota, TORX T25 gremdgalva	
	
ARTIKULS	CENA
FIXCON C - 6 × 50 Ø5mm	0.094
FIXCON C - 6 × 100 Ø5mm	0.182

Skrūve gāzbetonam KBRM, TORX T30 gremdgalva	
	
ARTIKULS	CENA
KBRM - 8 × 65	0.170
KBRM - 8 × 90	0.250
KBRM - 8 × 110	0.340

Skrūve gāzbetonam KBRM P, TORX T30 pusapaļa galva	
	
ARTIKULS	CENA
KBRM P - 8 × 65	0.210

Skrūve gāzbetonam, PH3 WAF galva	
	
ARTIKULS	CENA
181764 - 8 × 65	0.230



PFG enkurs ES balti cinkots	
SORMAT 	
	
ARTIKULS	CENA
PFG ES M6 - 10 × 40	0.690
PFG ES M8 - 14 × 50	0.830
PFG ES M10 - 16 × 60	1.180
PFG ES M12 - 20 × 80	1.990
PFG ES M16 - 25 × 100	3.570

Cilpskrūve SPEC 6 balti cinkota	
	
ARTIKULS	CENA
s6 - M6 × 55	0.380
s6 - M8 × 60	0.480
s6 - M10 × 73	0.780
s6 - M12 × 90	1.350
s6 - M16 × 95	2.780

Āķskrūve SPEC 4 balti cinkota	
	
ARTIKULS	CENA
s4 - M6 × 55	0.380
s4 - M8 × 60	0.550
s4 - M10 × 73	0.890
s4 - M12 × 90	1.550
s4 - M16 × 95	3.190

Tērauda enkurs LA balti cinkots	
SORMAT 	
	
ARTIKULS	CENA
LA M6 - 8 × 25	0.100
LA M8 - 10 × 30	0.130
LA M10 - 12 × 40	0.200
LA M12 - 15 × 50	0.330
LA M16 - 20 × 65	0.590

Skrūve betonam balti cinkota, TORX T30 gremdgalva			
			
ARTIKULS	CENA	ARTIKULS	CENA
142671 - 7.5 × 72	0.150	142674 - 7.5 × 132	0.230
142672 - 7.5 × 92	0.170	142676 - 7.5 × 152	0.290
142673 - 7.5 × 112	0.190		

Enkura uzstādīšanas instruments	
SORMAT 	
	
ARTIKULS	CENA
170135 - 6mm	3.300
170136 - 8mm	3.990
170137 - 10mm	5.690
170138 - 12mm	8.990
170139 - 16mm	13.000

Logu un durvju rāmju enkurs balti cinkots	
	
ARTIKULS	CENA
LDRE - 10 × 72	0.140
LDRE - 10 × 92	0.160
LDRE - 10 × 112	0.190
LDRE - 10 × 132	0.220
LDRE - 10 × 152	0.240
LDRE - 10 × 182	0.270
LDRE - 10 × 202	0.290



Misiņa enkurs SPEC 34	
	
ARTIKULS	CENA
s34mi M4 - 5 × 16	0.080
s34mi M5 - 6 × 20	0.090
s34mi M6 - 8 × 23	0.120
s34mi M8 - 10 × 28	0.160
s34mi M10 - 12 × 31	0.270
s34mi M12 - 16 × 38	0.510
s34mi M16 - 20 × 46	1.040

Metāla enkurs iekaramajiem griestiem	
	
ARTIKULS	CENA
GE - 6 × 40	0.090
GE - 6 × 65	0.130



Ekspandera nagla (zibens dībelis) cinkota			
			
ARTIKULS	CENA	ARTIKULS	CENA
ZD - 6 × 40	0.060	ZD - 8 × 70	0.130
ZD - 6 × 60	0.080	ZD - 8 × 90	0.150
ZD - 6 × 80	0.120	ZD - 8 × 110	0.160

Dībelis gāzbetonam	
	
ARTIKULS	CENA
KGS - 6 × 32	0.080
KGS - 8 × 38	0.130
KGS - 8 × 60	0.140
KGS - 10 × 60	0.160

Neilona dībelis gāzbetonam KBT			
SORMAT 			
			
ARTIKULS	CENA	ARTIKULS	CENA
KBT4 - 10 × 50	0.150	KBT8 - 12 × 60	0.250
KBT6 - 10 × 50	0.190	KBT10 - 14 × 70	0.400

Skrūvenkurs MUNGO MHD-S balti cinkots	
	
	
ARTIKULS	CENA
MHD-S - 4 x 20/0-8	0.130
MHD-S - 4 x 32/3-13	0.150
MHD-S - 4 x 46/3-18	0.170
MHD-S - 4 x 46/16-24	0.170
MHD-S - 4 x 59/32-42	0.200
MHD-S - 5 x 37/5-15	0.230
MHD-S - 5 x 52/5-21	0.260
MHD-S - 5 x 65/16-34	0.310
MHD-S - 5 x 80/32-50	0.340
MHD-S - 6 x 37/5-15	0.280
MHD-S - 6 x 52/5-21	0.310
MHD-S - 6 x 65/16-34	0.360
MHD-S - 6 x 80/32-50	0.400
MHD-S - 8 x 37/5-15	0.400
MHD-S - 8 x 52/5-21	0.440
MHD-S - 8 x 65/16-34	0.480
MHD-S - 8 x 80/32-50	0.540

Universālais neilona dībelis MUNGO MU	
	
ARTIKULS	CENA
MU - 6 x 35	0.040
MU - 6 x 45	0.050
MU - 8 x 50	0.060
MU - 10 x 60	0.110
MU - 12 x 70	0.185

Universālais neilona dībelis YLT	
	
	
ARTIKULS	CENA
YLT - 6 x 30	0.030
YLT - 8 x 50	0.050
YLT - 10 x 60	0.100

Skrūvenkuru pistole	
	
ARTIKULS	CENA
170010 -	7.900

Skrūvenkuru pistole	
	
ARTIKULS	CENA
170011 -	15.260

Metāla reģipša dībelis	
	
ARTIKULS	CENA
150216 - 12 x 30	0.140

Neilona reģipša enkurs OLA	
	
	
ARTIKULS	CENA
OLA - 10mm	0.180

Neilona reģipša dībelis	
	
ARTIKULS	CENA
150201 -	0.060

Neilona reģipša dībelis MFJ	
	
ARTIKULS	CENA
MFJ - 12 x 29	0.070
MFJ-S - 12 x 29 (ar skrūvi)	0.110

Atsperiekare ar āķi	
	
ARTIKULS	CENA
160210 - 4 x 75	0.300

Metāla reģipša dībelis	
	
ARTIKULS	CENA
150202 -	0.100

Metāla reģipša dībelis MJP	
	
ARTIKULS	CENA
MJP - 12 x 39	0.130
MJP-S - 12 x 39 (ar skrūvi)	0.180

Fasādes izolācijas dībelis ar metāla naglu LFM (garā izplešanās zona)



Iegremdējama dziļums: 80mm



ARTIKULS

CENA

LFM - 10 × 140 (200 gab.) Izol.biezums: 50mm	0.150
LFM - 10 × 160 (200 gab.) Izol.biezums: 70mm	0.170
LFM - 10 × 180 (200 gab.) Izol.biezums: 90mm	0.180
LFM - 10 × 200 (200 gab.) Izol.biezums: 110mm	0.200
LFM - 10 × 220 (100 gab.) Izol.biezums: 130mm	0.220
LFM - 10 × 260 (100 gab.) Izol.biezums: 170mm	0.270
LFM - 10 × 300 (100 gab.) Izol.biezums: 210mm	0.310

Fasādes izolācijas dībelis ar metāla naglu LFM (garā izplešanās zona)



Iegremdējama dziļums: 60mm



ARTIKULS

CENA

LFM - 8 × 100 (200 gab.) Izol.biezums: 30mm	0.110
LFM - 8 × 120 (200 gab.) Izol.biezums: 50mm	0.120
LFM - 8 × 140 (200 gab.) Izol.biezums: 70mm	0.150
LFM - 8 × 160 (200 gab.) Izol.biezums: 90mm	0.170
LFM - 8 × 180 (200 gab.) Izol.biezums: 110mm	0.180
LFM - 8 × 200 (200 gab.) Izol.biezums: 130mm	0.200

Fasādes izolācijas dībelis ar metāla naglu WK THERM (īsā izplešanās zona)



Iegremdējama dziļums: 25mm



ARTIKULS

CENA

WK THERM - 8 × 155 (200 gab.) Izol.biezums: 120mm	0.220
WK THERM - 8 × 175 (200 gab.) Izol.biezums: 140mm	0.250
WK THERM - 8 × 195 (200 gab.) Izol.biezums: 160mm	0.290
WK THERM - 8 × 215 (100 gab.) Izol.biezums: 180mm	0.330
WK THERM - 8 × 255 (100 gab.) Izol.biezums: 220mm	0.500

Izolācijas paplāksne PVC



ARTIKULS

CENA

152306 - 60mm (D5mm) 0.040

Izolācijas paplāksne PVC



ARTIKULS

CENA

152307 - 90mm (D10mm) 0.060

Siltumizolācijas frēze 20mm



ARTIKULS

CENA

152270 - 5.500

Tapa putuplastam



ARTIKULS

CENA

152271 - 0.060

Tapa vatei



ARTIKULS

CENA

152272 - 0.160

Izolācijas metāla paplāksne



ARTIKULS

CENA

152302 - 40mm (D6) 0.090

Izolācijas metāla paplāksne



ARTIKULS

CENA

152304 - 80 × 40mm (D7) 0.120

Dībelis putuplastam





ARTIKULS

CENA

151429 - 27 × 52 0.320

152430 - 27 × 82 0.570

Nagla melna	
	
ARTIKULS	CENA/kg
N - 1.2 × 20 (1kg=4550)	2.220
N - 1.4 × 25 (1kg=3100)	2.120
N - 1.4 × 32 (1kg=2700)	2.120
N - 1.6 × 40 (1kg=1500)	2.000
N - 2.0 × 40 (1kg=950)	1.570
N - 2.0 × 50 (1kg=795)	1.570
N - 2.5 × 60 (1kg=415)	1.370
N - 3.0 × 70 (1kg=235)	1.270
N - 3.0 × 80 (1kg=205)	1.270
N - 3.5 × 90 (1kg=140)	1.270
N - 4.0 × 100 (1kg=100)	1.270
N - 4.0 × 120 (1kg=85)	1.270
N - 5.0 × 150 (1kg=43)	1.270
N - 6.0 × 200 (1kg=22)	1.270
N - 8.0 × 300 (1kg=9)	1.680

Nagla balti cinkota	
	
ARTIKULS	CENA/kg
N ZN - 1.2 × 20	3.300
N ZN - 1.6 × 40	2.800
N ZN - 2 × 40	2.800
N ZN - 2 × 50	2.800
N ZN - 2.5 × 60	2.800
N ZN - 3 × 70	2.400
N ZN - 3 × 80	2.400
N ZN - 3.5 × 90	2.400
N ZN - 4 × 100	2.400

Kartridža nagla balti cinkota	
	
ARTIKULS	CENA
N NK - 3.75 × 27	0.110
N NK - 3.75 × 32	0.120
N NK - 3.75 × 37	0.130
N NK - 3.75 × 42	0.130
N NK - 3.75 × 47	0.130

Enkurnagla balti cinkota	
	
ARTIKULS	CENA/kg
N EN - 4 × 40	3.500
N EN - 4 × 50	3.500
N EN - 4 × 60	3.500
N EN - 4 × 75	3.500
N EN - 4 × 100	3.500

Nagla ar mazo galvu misiņota	
	
ARTIKULS	CENA
N MS - 1.4 × 20	0.012
N MS - 1.4 × 25	0.014
N MS - 1.4 × 30	0.016
N MS - 1.4 × 35	0.017
N MS - 1.4 × 40	0.020
N MS - 1.4 × 45	0.023
N MS - 1.4 × 50	0.025

Šifera nagla balti cinkota	
	
ARTIKULS	CENA/kg
N ŠN ZN - 4 × 100	2.960
N ŠN ZN - 4 × 120	2.960

Vītā nagla balti cinkota	
	
ARTIKULS	CENA/kg
N VN - 2.5 × 60	2.700
N VN - 3 × 70	2.700
N VN - 3 × 80	2.700
N VN - 3.4 × 90	2.700
N VN - 3.8 × 100	2.700
N VN - 4.5 × 125	2.700
N VN - 5 × 150	2.700

Papes nagla melna	
	
ARTIKULS	CENA/kg
N PAP - 2.0 × 20	2.550
N PAP - 2.0 × 25	2.550
N PAP - 2.5 × 32	2.550
N PAP - 2.5 × 40	2.550

Papes nagla balti cinkota	
	
ARTIKULS	CENA/kg
N PAP ZN - 2.0 × 20	2.550
N PAP ZN - 2.0 × 25	2.550
N PAP ZN - 2.5 × 32	2.550
N PAP ZN - 2.5 × 40	2.550

Papes nagla HDG (karsti cinkota)	
	
ARTIKULS	CENA/kg
N PAP HDG - 2 × 25	4.350
N PAP HDG - 3 × 30	4.350
N PAP HDG - 2.5 × 35	4.350

Kniede DIN 7337 alumīnijs/tērauds



ARTIKULS	CENA
7337 A/S - 3.2 × 6	0.010
7337 A/S - 3.2 × 8	0.011
7337 A/S - 3.2 × 10	0.011
7337 A/S - 3.2 × 12	0.012
7337 A/S - 3.2 × 14	0.014
7337 A/S - 3.2 × 16	0.017
7337 A/S - 4 × 6	0.012
7337 A/S - 4 × 8	0.013
7337 A/S - 4 × 10	0.014
7337 A/S - 4 × 12	0.016
7337 A/S - 4 × 14	0.017
7337 A/S - 4 × 16	0.018
7337 A/S - 4 × 18	0.021
7337 A/S - 4 × 20	0.023
7337 A/S - 4.8 × 8	0.017
7337 A/S - 4.8 × 10	0.017
7337 A/S - 4.8 × 12	0.019
7337 A/S - 4.8 × 14	0.022
7337 A/S - 4.8 × 16	0.024
7337 A/S - 4.8 × 18	0.026
7337 A/S - 4.8 × 20	0.030
7337 A/S - 6.0 × 12	0.047
7337 A/S - 6.0 × 15	0.049
7337 A/S - 6.0 × 18	0.053
7337 A/S - 6.4 × 12	0.061
7337 A/S - 6.4 × 15	0.066
7337 A/S - 6.4 × 18	0.069

Vītņkniede ar cilindrisku galvu DIN 7338



ARTIKULS	CENA
7338 - M5 (0.5-2.5)	0.050
7338 - M5 (2.5-5.0)	0.060
7338 - M6 (0.5-3.0)	0.071
7338 - M6 (3.0-5.5)	0.078
7338 - M8 (1.0-3.5)	0.098
7338 - M8 (3.5-6.0)	0.098
7338 - M10 (1.0-4.0)	0.118
7338 - M10 (4.0-6.5)	0.129

Vītņu kniežu stanga GO-10-SP (VKC M5-M10)



ARTIKULS	CENA
120670 -	209.000

Kniede DIN 7337 ar paplatinātu galvu alumīnijs/tērauds



ARTIKULS	CENA
7337 A/S P - 3.2 × 8	0.021
7337 A/S P - 3.2 × 10	0.026
7337 A/S P - 3.2 × 12	0.030
7337 A/S P - 4 × 10	0.030
7337 A/S P - 4 × 12	0.034
7337 A/S P - 4 × 14	0.038
7337 A/S P - 4 × 16	0.041
7337 A/S P - 4 × 18	0.043
7337 A/S P - 4 × 20	0.044
7337 A/S P - 4.8 × 10	0.036
7337 A/S P - 4.8 × 12	0.040
7337 A/S P - 4.8 × 14	0.041
7337 A/S P - 4.8 × 16	0.043
7337 A/S P - 4.8 × 18	0.048
7337 A/S P - 4.8 × 20	0.059
7337 A/S P - 4.8 × 24	0.070

Divu pozīciju kniežu stanga 250mm (A/S 3.2-4.8mm)



ARTIKULS	CENA
309607 -	13.850

Kniežu stanga 250mm (A/S 2.4-4.8mm)



ARTIKULS	CENA
309609 -	12.000

Kniežu stangas ar grozāmu galu (A/S 2.4-4.8mm)



ARTIKULS	CENA
285212 -	31.200

Kniede DIN 7337 alumīnijs/tērauds, krāsota



ARTIKULS	CENA
7337 RR11 - 3.2 × 8	0.012
7337 RR20 - 3.2 × 8	0.012
7337 RR21 - 3.2 × 8	0.012
7337 RR22 - 3.2 × 8	0.012
7337 RR23 - 3.2 × 8	0.012
7337 RR28 - 3.2 × 8	0.012
7337 RR29 - 3.2 × 8	0.012
7337 RR30 - 3.2 × 8	0.012
7337 RR31 - 3.2 × 8	0.012
7337 RR32 - 3.2 × 8	0.012
7337 RR33 - 3.2 × 8	0.012
7337 RR35 - 3.2 × 8	0.012
7337 RR37 - 3.2 × 8	0.012
7337 RR40 - 3.2 × 8	0.012
7337 RR41 - 3.2 × 8	0.012
7337 RR750 - 3.2 × 8	0.012

Kniežu stanga MR33 (A/S 2.5-4mm)



ARTIKULS	CENA
300900 - MR33	15.700

Kniežu stanga MR55 (A/S 2.5-5mm)



ARTIKULS	CENA
300901 - MR55	27.000

Kniežu stanga (A/S 3.2-4.8mm)



ARTIKULS	CENA
286592 -	15.450

Skavu pistole M53 (M53 skavas 4-14mm)



ARTIKULS CENA

309615 - 10.000

Skavu pistole M11 (M11 4-14mm, M36 10-14mm, nagla)



ARTIKULS CENA

309614 - 20.000

Skavas M53 (11.3×0.7mm) (1000 gab.)



ARTIKULS CENA

283593 - 6mm	1.100
283594 - 8mm	1.220
283595 - 10mm	1.340
283596 - 12mm	1.530
283597 - 14mm	1.590

Skavas M11 (10.6×1.2mm) (1000 gab.)



ARTIKULS CENA

286603 - 6mm	1.550
286604 - 8mm	1.800
286605 - 10mm	2.030
286606 - 12mm	2.320
286607 - 14mm	2.600

Nagla (14×1.2mm) (1000 gab.)



ARTIKULS CENA

309606 - 14mm 2.100

Skavu pistole R34 (skavas 140 6-14mm)



ARTIKULS CENA

301516 - R34 53.850

Skavu pistole R36 (skavas 36)



ARTIKULS CENA

301511 - R36 69.000

RAPID skavas 140 (10.6×1.3mm)



ARTIKULS CENA

301540 - 6mm(2000 gb.)	6.400
301539 - 6mm(5000 gb.)	14.250
301542 - 8mm(2000 gb.)	7.200
301541 - 8mm(5000 gb.)	15.810
301543 - 10mm(2000 gb.)	7.600
301544 - 10mm(5000 gb.)	16.700
301546 - 12mm(2000 gb.)	8.630
301545 - 12mm(5000 gb.)	18.900
301547 - 14mm(2000 gb.)	9.400
301548 - 14mm(5000 gb.)	20.680

RAPID skavas 13 (10.6×0.7mm)



ARTIKULS CENA

301532 - 6mm(2500 gb.)	7.240
301531 - 6mm(5000 gb.)	11.600
301534 - 8mm(2500 gb.)	7.650
301533 - 8mm(5000 gb.)	12.000
301536 - 10mm(2500 gb.)	8.400
301535 - 10mm(5000 gb.)	13.420
301528 - 12mm(2500 gb.)	9.300
301529 - 12mm(5000 gb.)	14.700
301537 - 14mm(2500 gb.)	9.900
301538 - 14mm(5000 gb.)	15.970

RAPID skavas 36 (7.7×1.3mm)



ARTIKULS CENA

301587 - 14mm(1000 gb.) 8.400

Skavu pistole R33 (skavas 13 6-14mm)



ARTIKULS CENA

301510 - R33 53.850

Leņķis ar perforētiem caurumiem



ARTIKULS	CENA
L - 40 × 40 × 20 × 2	0.110
L - 40 × 40 × 40 × 2	0.160
L - 40 × 40 × 40 × 2.5	0.160
L - 40 × 40 × 60 × 2	0.220
L - 40 × 40 × 60 × 2.5	0.220
L - 60 × 60 × 40 × 2	0.220
L - 60 × 60 × 40 × 2.5	0.220
L - 60 × 60 × 50 × 2	0.280
L - 60 × 60 × 60 × 2	0.310
L - 60 × 60 × 60 × 2.5	0.310
L - 60 × 60 × 80 × 2.5	0.380
L - 60 × 60 × 100 × 2.5	0.480
L - 80 × 80 × 60 × 2	0.390
L - 80 × 80 × 60 × 2.5	0.390
L - 80 × 80 × 80 × 2	0.500
L - 80 × 80 × 80 × 2.5	0.500
L - 80 × 80 × 100 × 2	0.620
L - 100 × 100 × 60 × 2	0.500
L - 100 × 100 × 80 × 2	0.630
L - 100 × 100 × 100 × 2	0.750

Leņķis pastiprināts ar ribi



ARTIKULS	CENA
LS - 50 × 50 × 35 × 2	0.150
LS - 50 × 50 × 35 × 2.5	0.170
LS - 70 × 70 × 55 × 2	0.280
LS - 70 × 70 × 55 × 2.5	0.340
LS - 90 × 50 × 55 × 2.5	0.280
LS - 90 × 90 × 65 × 2	0.380
LS - 90 × 90 × 65 × 2.5	0.450
LS - 100 × 100 × 90 × 2	0.610
LS - 105 × 105 × 90 × 2	0.660
LS - 105 × 105 × 90 × 2.5	0.880
LS - 105 × 105 × 90 × 3	0.900
LS - 120 × 120 × 90 × 3	1.280
LS - 140 × 140 × 65 × 2.5	0.900
LS - 140 × 140 × 90 × 3	1.480
LS - 145 × 145 × 90 × 2.5	1.480

Leņķis 135°



ARTIKULS	CENA
L135 - 50 × 50 × 35 × 2.5	0.210
L135 - 70 × 70 × 55 × 2.5	0.450
L135 - 90 × 90 × 65 × 2.5	0.690
L135 - 105 × 105 × 90 × 2.5	1.100

Leņķis



ARTIKULS	CENA
L - 50 × 50 × 35 × 2	0.150
L - 50 × 50 × 35 × 2.5	0.200
L - 70 × 70 × 55 × 2	0.280
L - 70 × 70 × 55 × 2.5	0.370
L - 90 × 90 × 65 × 2	0.380
L - 90 × 90 × 65 × 2.5	0.480
L - 100 × 100 × 90 × 2	0.610
L - 105 × 105 × 90 × 2.5	0.880
L - 105 × 105 × 90 × 3	0.900
L - 150 × 50 × 35 × 2.5	0.350

Leņķis regulējams



ARTIKULS	CENA
LR - 50 × 55 × 30 × 2	0.140
LR - 70 × 55 × 30 × 2	0.170
LR - 80 × 55 × 30 × 2	0.190
LR - 120 × 55 × 30 × 2	0.310

Betona leņķis



ARTIKULS	CENA
BL - 75 × 75 × 50 × 6	1.490

Enkurleņķis



ARTIKULS	CENA
EL - 200 × 40 × 40 × 2	0.420
EL - 300 × 40 × 40 × 2	0.570
EL - 400 × 40 × 40 × 2	0.770

Savienojuma plate ar perforētiem caurumiem



ARTIKULS	CENA
P - 40 × 80 × 2	0.160
P - 40 × 100 × 2	0.180
P - 40 × 120 × 2	0.200
P - 40 × 140 × 2	0.250
P - 40 × 160 × 2	0.260
P - 60 × 120 × 2	0.330
P - 60 × 140 × 2	0.360
P - 60 × 160 × 2	0.390
P - 60 × 200 × 2	0.480
P - 60 × 240 × 2	0.580
P - 60 × 300 × 2	0.780
P - 80 × 200 × 2	0.560
P - 80 × 240 × 2	0.730
P - 80 × 300 × 2	0.980
P - 100 × 140 × 2	0.650
P - 100 × 200 × 2	0.780
P - 100 × 300 × 2	1.190
P - 120 × 300 × 2	1.420
P - 160 × 400 × 2	2.440
P - 1200 × 40 × 2	2.100
P - 1200 × 60 × 2	3.050

Savienojuma plate



ARTIKULS	CENA
PLC - 35 × 200 × 2.5	0.380
PLC - 55 × 140 × 2.5	0.450
PLC - 55 × 280 × 2.5	0.860
PLC - 65 × 180 × 2.5	0.680

Montāžas lēta savilces PVA

SORMAT



ARTIKULS	CENA
PVA - 12 × 0.75mm/10m	5.660
PVA - 12 × 0.75mm/30m	11.400
PVA - 12 × 1.00mm/10m	5.660
PVA - 12 × 1.00mm/30m	11.400
PVA - 17 × 0.75mm/10m	7.090
PVA - 17 × 0.75mm/30m	14.150
PVA - 17 × 1.00mm/10m	7.090
PVA - 17 × 1.00mm/30m	14.150

Montāžas lēta perforēta



ARTIKULS	CENA
MLP - 25 × 1.50mm/10m	7.960
MLP - 25 × 1.50mm/25m	19.900
MLP - 40 × 2.00mm/10m	16.900
MLP - 40 × 2.00mm/25m	42.700
MLP - 60 × 2.00mm/10m	26.800

Montāžas lēta KVA

SORMAT



ARTIKULS	CENA
KVA - 12 × 0.75mm/10m	5.400
KVA - 12 × 0.75mm/30m	11.070
KVA - 19 × 0.75mm/10m	6.770
KVA - 19 × 0.75mm/30m	12.450
KVA - 19 × 1.00mm/10m	7.100
KVA - 19 × 1.00mm/30m	13.490

T veida plate



ARTIKULS	CENA
TP - 150 × 127 × 38 × 2	0.450

Stabu blasts



ARTIKULS	CENA
STB - 46 × 550	2.700
STB - 71 × 750	4.720
STB - 91 × 750	6.220
STB - 101 × 900	8.700
STB - 121 × 900	9.300

Spāru leņķis



ARTIKULS	CENA
SL - 32 × 170 L	0.330
SL - 32 × 170 K	0.330
SL - 32 × 210 L	0.430
SL - 32 × 210 K	0.430
SL - 32 × 250 L	0.600
SL - 32 × 250 K	0.600
SL - 32 × 290 L	0.700
SL - 32 × 290 K	0.700

Betonējams "U" veida balsta stiprinājums





ARTIKULS	CENA
BBS - 61 × 324	3.120
BBS - 81 × 325	3.880
BBS - 101 × 325	4.030
BBS - 121 × 325	4.180
BBS - 141 × 325	4.340

Brusu kurpe



ARTIKULS	CENA
BK - 25 × 118	0.860
BK - 41 × 110	0.860
BK - 41 × 140	1.020
BK - 45 × 108	0.860
BK - 45 × 138	1.020
BK - 51 × 105	0.860
BK - 51 × 135	1.020
BK - 60 × 100	0.860
BK - 60 × 130	1.020
BK - 76 × 122	1.020
BK - 80 × 120	1.020
BK - 80 × 150	1.190
BK - 100 × 140	1.190
BK - 100 × 170	1.330
BK - 120 × 160	1.330
BK - 140 × 180	1.530

Kēde DIN 766 (īso posmu) balti cinkota	
	
ARTIKULS	CENA/m
766 - 2mm	0.460
766 - 3mm	0.610
766 - 4mm	1.000
766 - 5mm	1.390
766 - 6mm	2.100
766 - 8mm	3.560

Kēde DIN 763 (garo posmu) balti cinkota	
	
ARTIKULS	CENA/m
763 - 2mm	0.420
763 - 3mm	0.480
763 - 4mm	0.780
763 - 5mm	1.150
763 - 6mm	1.650
763 - 8mm	2.950

Troše balti cinkota	
	
ARTIKULS	CENA/m
T(1×7) - 0.6mm	0.050
T(1×7) - 1.0mm	0.060
T(1×19) - 2.0mm	0.120
T(6×7) - 3.0mm	0.170
T(6×7) - 4.0mm	0.300
T(6×7) - 5.0mm	0.520
T(6×19) - 6.0mm	0.680
T(6×19) - 8.0mm	1.180
T(6×36) - 10.0mm	1.850
T(6×36) - 12.0mm	2.600

Virve balta (poliestera)	
	
ARTIKULS	CENA
193000 - 1mm×100m	1.600
193003 - 1.5mm×50m	1.800
193024 - 2mm×50m	2.360

Virve melna (poliestera)	
	
ARTIKULS	CENA
193001 - 1mm×100m	1.600
193002 - 1.5mm×50m	1.800
193023 - 2mm×50m	2.360

Troše balti cinkota ar PVC pārklājumu	
	
ARTIKULS	CENA/m
T+PVC(6×7) - 2/3mm	0.270
T+PVC(6×7) - 3/5mm	0.530
T+PVC(6×7) - 4/6mm	0.850
T+PVC(6×7) - 5/7mm	1.120

Virve dažādas krāsas (polipropilēna multifilamenta)	
	
ARTIKULS	CENA
192989 - 1.5mm×50m Dz	1.700
192990 - 1.5mm×50m Sk	1.700
192987 - 1.5mm×50m ZI	1.700

Virve dažādas krāsas (polipropilēna multifilamenta)	
	
ARTIKULS	CENA
193031 - 2mm×50m Dz	1.900
193042 - 2mm×50m Sk	1.900
193041 - 2mm×50m ZI	1.900

Virve dažādas krāsas (polipropilēna multifilamenta)	
	
ARTIKULS	CENA
193105 - 3mm×50m	4.650
193110 - 4mm×25m	3.600
193120 - 5mm×20m	4.270
193130 - 6mm×20m	5.450
193145 - 8mm×10m	4.820
193150 - 10mm×10m	7.580

Pīta virve balta (poliestera)	
	
ARTIKULS	CENA/m
193450 - 3mm	0.100
193451 - 4mm	0.130
193452 - 5mm	0.190
193453 - 6mm	0.260
193455 - 8mm	0.650
193456 - 10mm	0.780
193457 - 12mm	1.150
193459 - 16mm	2.400
193460 - 20mm	3.200

Virve vīta dzeltena (polipropilēna)	
	
ARTIKULS	CENA/m
193503 - 3mm	0.050
193504 - 4mm	0.080
193505 - 5mm	0.090
193506 - 6mm	0.120
193508 - 8mm	0.210
193509 - 10mm	0.360
193510 - 12mm	0.500
193512 - 16mm	0.920
193513 - 19mm	1.250

Virve dzeltena (polipropilēna) 2mm	
	
ARTIKULS	CENA
192979 - 2mm×100m	1.600
192980 - 2mm×200m	2.920
192982 - 2mm×500m	4.920

Cilpskrūve DIN 580 balti cinkota



ARTIKULS	CENA
580 - M6	0.430
580 - M8	0.510
580 - M10	0.770
580 - M12	1.080
580 - M16	1.800
580 - M20	3.500
580 - M24	5.210

Cilpuzgrieznis DIN 582 balti cinkots



ARTIKULS	CENA
582 - M6	0.510
582 - M8	0.510
582 - M10	0.730
582 - M12	1.040
582 - M16	1.710
582 - M20	2.440
582 - M24	4.930

Karabīne



ARTIKULS	CENA
190164 - 5×50mm	0.220
190165 - 6×60mm	0.280
190166 - 7×70mm	0.340
190167 - 8×80mm	0.440
190168 - 9×90mm	0.610
190169 - 10×100mm	0.720
190170 - 11×120mm	1.170
190171 - 12×140mm	1.500
190172 - 13×160mm	2.360

Troses žņaugis DIN 741



ARTIKULS	CENA
741 - 3mm	0.090
741 - 5mm	0.100
741 - 6mm	0.110
741 - 8mm	0.180
741 - 10mm	0.260
741 - 12mm	0.450
741 - 14mm	0.500
741 - 16mm	0.780
741 - 19mm	0.940
741 - 22mm	1.430
741 - 25mm	1.650

D-veida šķekelis



ARTIKULS	CENA
190221 - 5mm	0.190
190222 - 6mm	0.210
190223 - 8mm	0.360
190224 - 10mm	0.590
190225 - 12mm	0.880
190227 - 16mm	1.920
190229 - 20mm	3.300
190232 - 25mm	6.950

Karabīne ar aizskrūvējama aizslēgu



ARTIKULS	CENA
190368 - 5×50mm	0.360
190369 - 6×60mm	0.390
190370 - 7×70mm	0.510
190371 - 8×80mm	0.600
190373 - 10×100mm	1.010
190374 - 12×140mm	1.920

Troses savilcējs DUPLEX



ARTIKULS	CENA
190430 - 2mm	0.130
190431 - 3mm	0.150
190432 - 4mm	0.190
190433 - 5mm	0.270
190434 - 6mm	0.360

Troses cilpa DIN 6899



ARTIKULS	CENA
6899 - 3mm	0.110
6899 - 4mm	0.130
6899 - 5mm	0.150
6899 - 6mm	0.180
6899 - 8mm	0.200
6899 - 10mm	0.240
6899 - 12mm	0.260

Karabīne aizskrūvējama



ARTIKULS	CENA
190341 - 4mm	0.320
190342 - 5mm	0.360
190343 - 6mm	0.400
190345 - 8mm	0.720
190347 - 10mm	1.340
190348 - 12mm	2.110

SK tipa āķis 8.klase



ARTIKULS	CENA
192540 - 1.12t	4.230
192541 - 2.0t	4.290
192542 - 3.2t	8.570
192543 - 5.4t	16.460
192544 - 8.0t	27.160

Alumīnija troses kniede



ARTIKULS	CENA
191380 - 1mm	0.070
191381 - 1.5mm	0.080
191382 - 2mm	0.080
191383 - 3mm	0.090
191384 - 4mm	0.130
191385 - 5mm	0.200
191386 - 6mm	0.270

Spriegotājs DIN 1480 E/H
(āķis/cilpa)

ARTIKULS	CENA
1480 E/H - M5	0.710
1480 E/H - M6	0.950
1480 E/H - M8	1.220
1480 E/H - M10	1.760
1480 E/H - M12	2.470
1480 E/H - M16	4.850
1480 E/H - M20	8.420
1480 E/H - M24	15.000

Lentveida strope 1t



ARTIKULS	CENA
192050 - 1m	2.700
192051 - 2m	4.500
192052 - 3m	5.900
192053 - 4m	6.900

Kravu stiprināšanas siksnas 25mm, apļveida 250kg



ARTIKULS	CENA
192021 - 3m	2.020
192022 - 5m	2.600

Kravu stiprināšanas siksnas 35mm, apļveida 2500kg



ARTIKULS	CENA
192006 - 6m	8.970

Lentveida strope 2t



ARTIKULS	CENA
192059 - 2m	8.500
192060 - 3m	11.240
192061 - 4m	13.290
192062 - 5m	17.760
192063 - 6m	20.060
192064 - 8m	25.930

Kravu stiprināšanas siksnas 25mm, divdaļīga 600kg

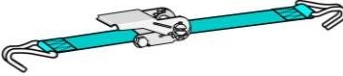

ARTIKULS	CENA
192016 - 5m	3.200

Kravu stiprināšanas siksnas 35mm, divdaļīga 2500kg

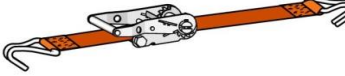

ARTIKULS	CENA
192015 - 6m	8.970
192014 - 8m	17.500

Lentveida strope 3t



ARTIKULS	CENA
192067 - 2m	15.650
192068 - 3m	17.500
192069 - 4m	20.500
192070 - 5m	27.600
192071 - 6m	29.900
192072 - 8m	43.900

Kravu stiprināšanas siksnas 25mm, divdaļīga 500kg

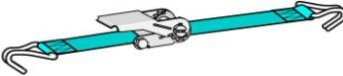

ARTIKULS	CENA
192017 - 10m	6.900

Kravu stiprināšanas siksnas 50mm, 4000kg



ARTIKULS	CENA
192010 - 10m	13.500

Kravu stiprināšanas siksnas 25mm, apļveida 600kg



ARTIKULS	CENA
192003 - 6m	3.700

Kravu stiprināšanas siksnas 50mm, 4000kg



ARTIKULS	CENA
192008 - 8m	13.700

Gumijas kravas stiprināšanai (2gab)



ARTIKULS	CENA	ARTIKULS	CENA
216065 - 60cm	3.380	216068 - 100cm	5.070
216066 - 80cm	4.720	216069 - 120cm	5.700

Kravu stiprināšanas siksnas 50mm, 5000kg

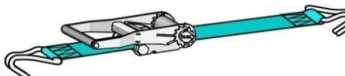

ARTIKULS	CENA
192019 - 10m	13.980
192018 - 20m	26.190

BŪVMATERIĀLI

Ģipškartons, profili	43
Profilu stiprinājumi, SHEETROCK	44
Stūri	45
Cokollīstes, montāžas profili, konsoles	46
Līmlentas, palešu plēve	47
Plēves, pārklāji	48
ETERNIT bezazbesta viļņotās loksnes	49
Ruberoīds, uzkausējamais jumta segums	51
Betonēšanas piederumi	53

Cena norādīta ar PVN

Gipškartons GKB (balts)



ARTIKULS	CENA
GKB - 2000×1200×12.5mm	
GKB - 2600×1200×12.5mm	
GKB - 3000×1200×12.5mm	

Gipškartons mitrumizturīgs GKBI (zaļš)



ARTIKULS	CENA
GKBI - 2600×1200×12.5mm	
GKBI - 3000×1200×12.5mm	

Sietlenta pašlīmejoša



ARTIKULS	CENA
313611 - 48mm×20m	1.040
313609 - 48mm×45m	2.100
313612 - 48mm×90m	4.180
313614 - 48mm×180m	8.200
313615 - 100mm×20m	2.100
313616 - 150mm×20m	3.130

Amortizējoša līmlenta



ARTIKULS	CENA
313400 - 30mm×30m	3.450
313401 - 50mm×30m	5.350
313402 - 70mm×30m	8.000
313403 - 95mm×30m	10.680

CD reģipša profils (griestu vertikālie profili) 0.5mm



ARTIKULS	CENA
CD - 60×27mm 2.6m	1.400
CD - 60×27mm 3.0m	1.420
CD - 60×27mm 4.0m	1.880

UD reģipša profils (griestu perimetra horizontālie profili) 0.5mm



ARTIKULS	CENA
UD - 28×27mm 3.0m	0.920

CW reģipša profils (starpstienu vertikālie profili) 0.5mm



ARTIKULS	CENA
CW - 50x50mm 2.6m	2.040
CW - 50x50mm 3.0m	2.360
CW - 75x50mm 2.6m	2.210
CW - 75x50mm 3.0m	2.550
CW - 100x50mm 2.6m	2.560
CW - 100x50mm 3.0m	2.960
CW - 100x50mm 4.0m	4.060

UW reģipša profils (starpstienu horizontālie profili) 0.5mm



ARTIKULS	CENA
UW - 50x40mm 3.0m	1.810
UW - 75x40mm 3.0m	2.130
UW - 100x40mm 3.0m	2.550

"U" veida skavas



ARTIKULS	CENA
313321 - 60x75mm	0.080
313322 - 60x120mm	0.100
313324 - 60x175mm	0.290
313326 - 60x225mm	0.380

CD šķērssavienotājs



ARTIKULS	CENA
313406 -	0.140

CD garenvirziena savienotājs



ARTIKULS	CENA
313405 -	0.130

Stieple ar cilpu



ARTIKULS	CENA
313409 - 25cm	0.080
313410 - 50cm	0.140
313411 - 75cm	0.210
313412 - 100cm	0.280
313415 - 150cm	0.400

CD krusta savienojums



ARTIKULS	CENA
313408 -	0.450

CD "T" veida savienotājs



ARTIKULS	CENA
313419 -	0.160

CD ātrā enkuriere



ARTIKULS	CENA
313404 -	0.200

Piekāršanas dubultatspere



ARTIKULS	CENA
313426 -	0.260

Profilu savienotājs



ARTIKULS	CENA
286597 - 260mm	23.000

Profilu savienotājs



ARTIKULS	CENA
286596 - 350mm	23.900

Metāla enkurs ar cilpu iekaramajiem griestiem



ARTIKULS	CENA
173500 - 6 x 60	0.140

Špaktele SHEETROCK FILL&FINISH (zila) 20kg



ARTIKULS	CENA
313094 -	23.900

Špaktele SHEETROCK SUPER FINISH (zaļa) 20kg





ARTIKULS	CENA
313095 -	17.900

Metāla stūra lenta



ARTIKULS	CENA
313620 - 52mmx30m	8.600

Reģipša stūris alumīnija	
	
ARTIKULS	CENA
313517 - 19x19mm 2.5m	0.460
313518 - 19x19mm 3m	0.550
313519 - 23x23mm 2.5m	0.550
313520 - 23x23mm 3m	0.620

"J" nobeiguma līste PVC	
	
ARTIKULS	CENA
313530 - 2.5m	0.640
313531 - 3.0m	0.780

Reģipša stūris cinkots	
	
ARTIKULS	CENA
313552 - 25x25mm 2.5m	1.170
313553 - 25x25mm 3.0m	1.400

"J" nobeiguma līste cinkota	
	
ARTIKULS	CENA
313526 - 2.5m	1.500
313527 - 3.0m	1.840

Reģipša stūris PVC	
	
ARTIKULS	CENA
313525 - 25x25mm 2.5m	0.530

PVC stūris arkām	
	
ARTIKULS	CENA
313535 - 3.0m	0.630

Apmetuma vadula W6 cinkota	
	
ARTIKULS	CENA
313555 - 2.5m	0.580
313556 - 3.0m	0.700

PVC stūris ar sietu 8x12cm	
	
ARTIKULS	CENA
313488 - 80x120mm 2.5m	0.960
313489 - 80x120mm 3.0m	1.160

Apmetuma vadula W10 cinkota	
	
ARTIKULS	CENA
313557 - 2.5m	0.630
313558 - 3.0m	0.750

PVC stūris ar sietu 10x15cm	
	
ARTIKULS	CENA
313485 - 100x150mm 2.5m	1.400

Apmetuma stūris cinkots	
	
ARTIKULS	CENA
313545 - 2.5m	0.610
313546 - 3.0m	0.730

Cokollīstes distancers	
	
ARTIKULS	CENA
313502 - 3mm	0.040
313504 - 5mm	0.060
313505 - 8mm	0.070
313506 - 10mm	0.080
313507 - 15mm	0.100

Cokollīstes savienotājs	
	
ARTIKULS	CENA
313500 -	0.080

Stikla šķiedras siets 160g/m ² (1×50m)	
	
ARTIKULS	CENA
303256 -	0.680

U veida profila konsole	
	
ARTIKULS	CENA
160190 - 250mm	3.800
160191 - 300mm	4.160
160192 - 400mm	5.300
160193 - 500mm	5.970
160194 - 600mm	7.100
160196 - 800mm	11.000
160197 - 1000mm	14.200

Cokollīste	
	
ARTIKULS	CENA
313490 - 53×0.6mm 2m	2.400
313494 - 103×0.6mm 2m	3.640
313497 - 153×0.8mm 2m	6.080

L veida profils	
	
ARTIKULS	CENA
160170 - 30×30×2mm 2m	4.900

U veida profils	
	
ARTIKULS	CENA
160172 - 30×30×2mm 2m	5.900
160173 - 30×30×3mm 2m	9.100

Savilces lenta QIP 30m	
	
ARTIKULS	CENA
330785 - QIP lenta 30m	21.250
330780 - stiprinājums	0.600

Stiprinājums Z veida ar gumiju BRA-Z	
	
ARTIKULS	CENA
202401 -	1.200

Stiprinājums V veida ar gumiju BRA-V	
	
ARTIKULS	CENA
202405 -	0.630

Stiprinājums L veida ar gumiju BRA-L	
	
ARTIKULS	CENA
202400 -	1.140

Auduma mitrumizturīgā līmlente



ARTIKULS	CENA
287530 - 48mm×10m, pel.	1.600
287531 - 48mm×10m, mel.	1.600
287532 - 48mm×25m, pel.	2.700
287533 - 48mm×25m, mel.	2.700
287534 - 48mm×50m, pel.	4.800
287535 - 48mm×50m, mel.	4.800

Krāsotāju lente 60°C



ARTIKULS	CENA
287500 - 19mm×50m	0.850
287501 - 25mm×50m	1.000
287503 - 38mm×50m	1.370
287504 - 50mm×50m	1.850
287505 - 75mm×50m	2.770

Krāsotāju lente 80°C



ARTIKULS	CENA
287506 - 12mm×50m	0.640
287507 - 19mm×50m	1.080
287508 - 25mm×50m	1.380
287510 - 38mm×50m	1.950
287511 - 50mm×50m	2.560

Divpusējā līmlente



ARTIKULS	CENA
287622 - 50mm×5m	1.450
287620 - 50mm×10m	2.450
287625 - 50mm×25m	5.980

Iepakojuma līmlente SO



ARTIKULS	CENA
287560 - 38mm×66m crsp.	1.050
287561 - 38mm×66m brūn.	1.050
287565 - 48mm×66m crsp.	1.280
287566 - 48mm×66m brūn.	1.280
287574 - 75mm×66m crsp.	2.100
287575 - 75mm×66m brūn.	2.100

Aizsargplēve ar krāsotāju lentu



ARTIKULS	CENA
287520 - 550mm×33m	3.130
287521 - 1100mm×33m	4.450
287522 - 1400mm×33m	5.500
287523 - 1800mm×33m	5.500

Montāžas līmlente



ARTIKULS	CENA
287621 - 19mm×5m	3.850
287627 - 19mm×25m	9.980
287628 - 25mm×25m	12.700

Brīdinājuma lente (sarkan-balta)



ARTIKULS	CENA
310370 - 75mm×100m	2.700
310371 - 75mm×200m	4.100
310372 - 75mm×500m	9.000

Izolācijas lente 19mm×33m



ARTIKULS	CENA
287664 - melna	1.220
287665 - zila	1.220
287666 - sarkana	1.220
287667 - dzeltēna	1.220
287668 - pelēka	1.220
287670 - balta	1.220

Palešu plēve 17mkr (450mm×270m)



ARTIKULS	CENA
287683 - melna	7.800
287684 - caurspīdīga	6.300

Alumīnija līmlente



ARTIKULS	CENA
310325 - 50mm×50m	5.950
310326 - 75mm×50m	7.980
310327 - 100mm×50m	10.900

Armēta alumīnija līmlenta



ARTIKULS	CENA
287553 - 50mm×40m	7.260
287554 - 75mm×40m	10.530

Cena norādīta ar PVN

Aizsargplēve 0.018mm



ARTIKULS	CENA
308952 - 4x5m	1.300

Aizsargplēve 0.010mm



ARTIKULS	CENA
283002 - 4x5m	1.150

Aizsargplēve 0.005mm



ARTIKULS	CENA
283151 - 4x5m	0.600
283152 - 4x12.5m	1.420

Tvaika izolācijas plēve (3x25m) 75m²



ARTIKULS	CENA
331784 - 100mkr	16.100
331785 - 150mkr	19.050
331786 - 200mkr	24.500

Pārklājs (tents) 70g/m²



ARTIKULS	CENA
350865 - 1.7x2m	1.200
350851 - 2x3m	2.100
350852 - 3x4m	4.100
350853 - 3x5m	5.150
350854 - 4x5m	6.850
350855 - 4x6m	8.200
350856 - 6x8m	16.400
350857 - 6x10m	20.500
350858 - 8x10m	27.350
350859 - 10x12m	41.000
350867 - 12x15m	61.500
350868 - 12x18m	73.800
350869 - 15x20m	95.200
350870 - 20x20m	126.900

Tvaika izolācijas plēve DEN BRAVEN (2x50m) 100m²



ARTIKULS	CENA
282971 - 0.2mm	36.990

Tvaika izolācijas plēve SAMPLEX (3x45m) 135m²



ARTIKULS	CENA
331790 - 0.2mm	80.040

Antikondensāta plēve EUROVENT (1.5x50m) 75m²



ARTIKULS	CENA
331778 - 110g/m ²	38.330
331779 - 130g/m ²	43.370

Difūzijas membrāna TOPDACH (1.5x50m) 75m²



ARTIKULS	CENA
331761 - 100 g/m ²	46.280
331762 - 125 g/m ²	55.360
331764 - 150 g/m ²	69.880

Armēta plēve pamatiem DEN BRAVEN 0.3mm



ARTIKULS	CENA
282990 - 0.365x50m	14.360
282991 - 0.5x50m	20.160

Pretvēja plēve (1.5x50m) 75m²



ARTIKULS	CENA
331770 - 90 g/m ²	38.000



Pārklājs (tents) 120g/m²



ARTIKULS	CENA
350840 - 2x3m	4.120
350841 - 3x4m	8.240
350842 - 3x5m	10.300
350845 - 4x6m	16.470
350846 - 6x8m	32.930
350848 - 8x10m	54.860
350849 - 10x12m	82.310
350850 - 12x15m	123.470

Bezazbesta viļņotā loksne ETERNIT KLASIKA M (1250×1130mm)

Loksnes laukums: 1.41 m ² Lietderīgais laukums: 1.16 m ²	Loksnes svars: 14.5 kg Loksnes uz paletes: 100 gab.	Biezums: 6 mm Kalpošanas laiks: 50+ gadi
---	--	---









ARTIKULS	CENA
333560 - Nekrāsota (pelēka)	
333561 - BL11 (ķieģeļu sarkana)	
333562 - BL21 (brūna)	
333563 - BL22 (ķiršu sarkana)	
333564 - BL31 (zaļa)	

Bezazbesta viļņotā loksne ETERNIT KLASIKA L (1750×1130mm)

Loksnes laukums: 1.98 m ² Lietderīgais laukums: 1.68 m ²	Loksnes svars: 22.5 kg Loksnes uz paletes: 100 gab.	Biezums: 6 mm Kalpošanas laiks: 50+ gadi
---	--	---









ARTIKULS	CENA
333570 - Nekrāsota (pelēka)	
333571 - BL11 (ķieģeļu sarkana)	
333572 - BL21 (brūna)	
333573 - BL22 (ķiršu sarkana)	
333574 - BL31 (zaļa)	
333575 - Caurspīdīga	

Bezazbesta viļņotā loksne ETERNIT KLASIKA XL (2500×1130mm)

Loksnes laukums: 2.83 m ² Lietderīgais laukums: 2.47 m ²	Loksnes svars: 34.5 kg Loksnes uz paletes: 60 gab.	Biezums: 6 mm Kalpošanas laiks: 50+ gadi
---	---	---



ARTIKULS	CENA
333580 - Nekrāsota (pelēka)	
333581 - BL11 (ķieģeļu sarkana)	
333582 - BL21 (brūna)	
333583 - BL22 (ķiršu sarkana)	
333584 - BL31 (zaļa)	
333585 - Caurspīdīga	

Bezazbesta viļņotā loksne ETERNIT GOTIKA (585×920mm)

Loksnes laukums: 0.54 m²
Lietderīgais laukums: 0.40 m²

Loksnes svars: 7.0 kg
Loksnes uz paletes: 300 gab.

Biezums: 6 mm
Kalpošanas laiks: 50+ gadi



ARTIKULS

CENA

333600 - Nekrāsota (pelēka)

333601 - BL11 (ķieģeļu sarkana)

333602 - BL12 (tumši sarkana)

333603 - BL21 (brūna)

333604 - BL22 (ķiršu sarkana)

333605 - BL31 (zaļa)

333606 - BL91 (melna)

Bezazbesta viļņotā loksne ETERNIT BALTIJAS VILNIS (875×920mm)

Loksnes laukums: 0.81 m²
Lietderīgais laukums: 0.65 m²

Loksnes svars: 10.6 kg
Loksnes uz paletes: 200 gab.

Biezums: 6 mm
Kalpošanas laiks: 50+ gadi



ARTIKULS

CENA

333610 - Nekrāsota (pelēka)

333611 - BL11 (ķieģeļu sarkana)

333612 - BL12 (tumši sarkana)

333613 - BL21 (brūna)

333614 - BL22 (ķiršu sarkana)

333615 - BL31 (zaļa)

333616 - BL91 (melna)

333618 - Caurspīdīga

ETERNIT skrūve krāsota, TORX T25

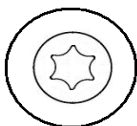

ARTIKULS

CENA

ETERNIT - 6×100

0.090

Cena norādīta ar PVN

Ruberoīds RPPO-300
(1×15m)



ARTIKULS CENA

312569 -

Ruberoīds K-350
(1×10m)



ARTIKULS CENA

312570 -

Pergamīns



ARTIKULS CENA

312571 -

Uzkausējamais bitumena jumta segums TECHNINICOL ECOFLEX (10-15 gadi)
(Lokanība: 0°C Karstumizturība: +130°C)

ECOFLEX HKP 3.5 kg/m² virsklājs
stiklauduma bāze (1×10m)



TECHNO
NICOL

ARTIKULS CENA

312500 -

ECOFLEX HKP 4.0 kg/m² virsklājs
stiklauduma bāze (1×10m)



TECHNO
NICOL

ARTIKULS CENA

312501 -

ECOFLEX EKP 4.0 kg/m² virsklājs
poliesteru bāze (1×10m)



TECHNO
NICOL

ARTIKULS CENA

312503 -

ECOFLEX HPP 3.0 kg/m² apakšklājs
stiklauduma bāze (1×10m)



TECHNO
NICOL

ARTIKULS CENA

312505 -

ECOFLEX HPP 2.0 kg/m² apakšklājs
stiklauduma bāze (1×15m)



TECHNO
NICOL

ARTIKULS CENA

312506 -

ECOFLEX EPP 3.0 kg/m² apakšklājs
poliesteru bāze (1×10m)



TECHNO
NICOL

ARTIKULS CENA

312508 -

Uzkausējamais bitumena jumta segums TECHNINICOL BICROELAST (10 gadi)
(Lokanība: -10°C Karstumizturība: +85°C)

BICROELAST HKP 3.0 kg/m² virsklājs
stiklauduma bāze (1×15m)



TECHNO
NICOL

ARTIKULS CENA

312510 -

BICROELAST EKP 4.0 kg/m² virsklājs
poliesteru bāze (1×10m)



TECHNO
NICOL

ARTIKULS CENA

3125013 -

BICROELAST HPP 3.0 kg/m² apakšklājs
stiklauduma bāze (1×15m)



TECHNO
NICOL

ARTIKULS CENA

312515 -

BICROELAST EPP 4.0 kg/m² apakšklājs
poliesteru bāze (1×10m)



TECHNO
NICOL

ARTIKULS CENA

312518 -

Cena norādīta ar PVN

Uzkausējamais bitumena jumta segums TECHNOMICOL BIPOL (10-15 gadi)
(Lokanība: -15°C Karstumizturība: +85°C)

BIPOL HKP 4.0 kg/m² virsklājs
stiklauduma bāze (1×10m)



TECHNO NICOL

ARTIKULS CENA

312520 -

BIPOL HKP 4.5 kg/m² virsklājs
stiklauduma bāze (1×10m)



TECHNO NICOL

ARTIKULS CENA

312521 -

BIPOL EKP 4.0 kg/m² virsklājs
poliestera bāze (1×10m)



TECHNO NICOL

ARTIKULS CENA

312523 -

BIPOL EKP 4.5 kg/m² virsklājs
poliestera bāze (1×10m)



TECHNO NICOL

ARTIKULS CENA

312524 -

BIPOL HPP 3.0 kg/m² apakšklājs
stiklauduma bāze (1×15m)



TECHNO NICOL

ARTIKULS CENA

312526 -

BIPOL HPP 3.5 kg/m² apakšklājs
stiklauduma bāze (1×10m)



TECHNO NICOL

ARTIKULS CENA

312527 -

BIPOL EPP 3.0 kg/m² apakšklājs
poliestera bāze (1×15m)



TECHNO NICOL

ARTIKULS CENA

312529 -

BIPOL EPP 3.5 kg/m² apakšklājs
poliestera bāze (1×10m)



TECHNO NICOL

ARTIKULS CENA

312530 -

Uzkausējamais bitumena jumta segums TECHNOMICOL UNIFLEX (15-20 gadi)
(Lokanība: -20°C Karstumizturība: +95°C)

UNIFLEX HKP 4.0 kg/m² virsklājs
stiklauduma bāze (1×10m)



TECHNO NICOL

ARTIKULS CENA

312535 -

UNIFLEX EKP 5.0 kg/m² virsklājs
poliestera bāze (1×10m)



TECHNO NICOL

ARTIKULS CENA

312537 -

UNIFLEX HPP 4.0 kg/m² apakšklājs
stiklauduma bāze (1×10m)



TECHNO NICOL

ARTIKULS CENA

312539 -

UNIFLEX EPP 5.0 kg/m² apakšklājs
poliestera bāze (1×10m)



TECHNO NICOL

ARTIKULS CENA

312541 -

Armatūra		
		
ARTIKULS		CENA
A - 8 × 3000		1.140
A - 10 × 3000		1.800
A - 12 × 3000		2.320

Distancers horizontālais		
		
ARTIKULS		CENA
D HOR - 15/20		0.090
D HOR - 25/30		0.100
D HOR - 35/40		0.120
D HOR - 40/50		0.140
D HOR - 50/60		0.250
D HOR - 65/70		0.180

Sienamā stieple ar cilpām (1000 gab.)			
			
ARTIKULS	CENA	ARTIKULS	CENA
SS - 100 mm	6.800	SS - 140 mm	7.240
SS - 120 mm	6.960	SS - 180 mm	8.240

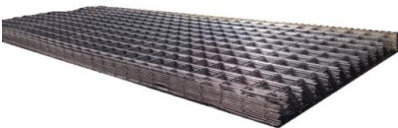
Armatūras siets 1×3m		
		
ARTIKULS		CENA
A SIETS - 3 × 100 × 100		3.520
A SIETS - 3 × 150 × 150		2.820
A SIETS - 4 × 100 × 100		5.800
A SIETS - 4 × 150 × 150		4.000
A SIETS - 5 × 100 × 100		8.420
A SIETS - 5 × 150 × 150		5.740
A SIETS - 6 × 100 × 100		13.500
A SIETS - 6 × 150 × 150		8.350

Distancers vertikālais		
		
ARTIKULS		CENA
D VER - 20/12		0.030
D VER - 20/20		0.080
D VER - 25/12		0.050
D VER - 25/20		0.090
D VER - 30/12		0.050
D VER - 30/20		0.100
D VER - 35/12		0.080
D VER - 35/20		0.130
D VER - 40/14		0.100
D VER - 40/20		0.170
D VER - 50/12		0.200
D VER - 50/20		0.280

Sienamā stieple (+/- 160g)		
		
ARTIKULS		CENA
SS - 20 kg		47.190
SS - kg		2.800

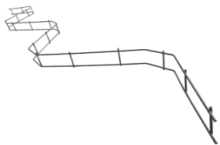
Starpvietu distancers (zig-zag veida) 2m		
		
ARTIKULS		CENA/m
SD ZIGZAG - 50 mm		0.760
SD ZIGZAG - 60 mm		0.760
SD ZIGZAG - 70 mm		0.780
SD ZIGZAG - 80 mm		0.890
SD ZIGZAG - 90 mm		0.910
SD ZIGZAG - 100 mm		0.940
SD ZIGZAG - 110 mm		0.960
SD ZIGZAG - 120 mm		0.990
SD ZIGZAG - 130 mm		1.030
SD ZIGZAG - 140 mm		1.160
SD ZIGZAG - 150 mm		1.200
SD ZIGZAG - 160 mm		1.240
SD ZIGZAG - 170 mm		1.270
SD ZIGZAG - 180 mm		1.310
SD ZIGZAG - 190 mm		1.330
SD ZIGZAG - 200 mm		1.370

INSTRUMENTI

Uzgaļi skrūvgriežiem	55
Skrūvgrieži	57
Seškantu atslēgas	58
Seškantu mucīņas	60
Āmuri	61
Laužņi, cirtņi, caurumsiši	62
Knaibles, grieznes	63
Naži, asmeņi	64
Zāģi	65
Atzīmēšanas instrumenti	66
Griezējdiski	67
Slīpēšanas diski, birstes	68
Smilšpapīrs, vītņgrieži, stikla griezēji	69
Slīplentas, vīles, metāla birstes	70
Urbji	71
Mērinstrumenti	73
Darba aizsardzības līdzekļi	75
Dārza instrumenti	77
Savilcējsiksnīņas	78
Spaiņi, maiši, mikseri	79
Špakelļāpsta, rīvdēļi, ķelles	80
Pistoles putām, hermētiķiem	81

Uzgalis PH2 25mm TiN Torsion



ARTIKULS CENA
309720 - PH2 TiN Torsion 1.050

Uzgalis PZ2 25mm TiN Torsion



ARTIKULS CENA
309721 - PZ2 TiN Torsion 1.050

Uzgalis PH2 pagarināts



ARTIKULS CENA
152400 - PH2/100mm 1.710
152401 - PH2/150mm 2.820
152402 - PH2/200mm 4.100
152403 - PH2/250mm 4.250
152404 - PH2/350mm 5.120

Uzgalis PH 25mm TiN (2 gabalu iepakojums)



ARTIKULS CENA
286400 - PH1 TiN 2.400
286401 - PH2 TiN 2.400
286402 - PH3 TiN 2.400

Uzgalis PZ 25mm TiN (2 gabalu iepakojums)



ARTIKULS CENA
286403 - PZ1 TiN 2.400
286404 - PZ2 TiN 2.400
286405 - PZ3 TiN 2.400

Uzgalis TORX 25mm TiN (2 gabalu iepakojums)



ARTIKULS CENA
286408 - T10 TiN 2.400
286409 - T15 TiN 2.400
286410 - T20 TiN 2.400
286411 - T25 TiN 2.400
286412 - T27 TiN 2.400
286413 - T30 TiN 2.400
286414 - T40 TiN 2.400

Uzgalis PH 25mm



ARTIKULS CENA
309707 - PH1 0.320
309708 - PH2 0.320
309709 - PH3 0.320

Uzgalis PZ 25mm



ARTIKULS CENA
309717 - PZ1 0.320
309718 - PZ2 0.320
309719 - PZ3 0.320

Uzgalis TORX 25mm



ARTIKULS CENA
164040 - T20 0.450
164041 - T25 0.450
164042 - T30 0.450
164043 - T40 0.450

Uzgalis PH 25mm



ARTIKULS CENA
300530 - PH1 0.670
300531 - PH2 0.670
300532 - PH3 0.670

Uzgalis PZ 25mm



ARTIKULS CENA
300535 - PZ1 0.670
300536 - PZ2 0.670
300537 - PZ3 0.670

Uzgalis HEX 25mm



ARTIKULS CENA
286416 - HEX2.5 1.000
286417 - HEX3 1.000
286418 - HEX4 1.000
286419 - HEX5 1.000
286420 - HEX6 1.000
286421 - HEX8 1.150

Uzgalis PH2 50mm



ARTIKULS CENA
309655 - PH2/50mm 0.600

Uzgalis PZ2 50mm



ARTIKULS CENA
309656 - PZ2/50mm 0.600

Uzgalis PH2 25mm Carbon Torsion



ARTIKULS	CENA
306021 - PH2 Carbon	1.920

Uzgalis PZ2 25mm Carbon Torsion



ARTIKULS	CENA
306024 - PZ2 Carbon	1.920

Magnētiskais uzgaļu turētājs alumīnija



ARTIKULS	CENA
309716 - 60mm	1.750

Uzgalis PH1 + PH2

STANLEY.



ARTIKULS	CENA
300538 - PH1+PH2	1.300

Uzgalis PZ1 + PZ2

STANLEY.



ARTIKULS	CENA
300539 - PZ1+PZ2	1.300

Magnētiskais uzgaļu turētājs alumīnija

STANLEY.



ARTIKULS	CENA
300540 - 60mm	4.600

Uzgalis SL 39mm

STANLEY.



ARTIKULS	CENA
286425 - 4.0mm	1.200
286426 - 5.5mm	1.200
286427 - 6.5mm	1.200
286428 - 8.0mm	1.500

HEX 25mm uzgaļu komplekts (2,3,4,5,6)



ARTIKULS	CENA
309693 - H2-H6	2.200

Magnētiskais uzgaļu turētājs



ARTIKULS	CENA
309713 - 100mm	0.850
309714 - 150mm	1.100

Uzgalis režģīša skrūvēm PH2



ARTIKULS	CENA
309706 - PH2	0.600

TORX 25mm uzgaļu komplekts (T10,T15,T20,T25,T30)



ARTIKULS	CENA
309694 - T10-T30	2.200

Uzgaļa adapters mucīnām 1/4 50mm

STANLEY.



ARTIKULS	CENA
300542 - 1/4	2.750

Magnētisks uzgaļu turētājs režģīša skrūvēm PH2



ARTIKULS	CENA
309710 - PH2	9.000

6-punktu uzgalis 45mm



ARTIKULS	CENA
309700 - 6mm	1.080
309704 - 7mm	1.100
309701 - 8mm	1.120
309702 - 10mm	1.150
309703 - 13mm	1.200

6-punktu uzgalis 45mm



ARTIKULS	CENA
308106 - 8mm	6.900
308107 - 10mm	6.900
308108 - 13mm	6.900

Skrūvgriezis 1000V SL

STANLEY.



ARTIKULS	CENA
300921 - SL3.5×75mm	4.640
300922 - SL4×100mm	4.860
300924 - SL5.5×150mm	5.000

Skrūvgriezis SL

MODECO



ARTIKULS	CENA	ARTIKULS	CENA
309742 - SL3×75mm	1.500	309747 - SL6×100mm	3.400
309743 - SL4×75mm	2.320	309748 - SL6×150mm	3.550
309744 - SL5×100mm	2.540	309749 - SL8×150mm	4.700
309745 - SL5×150mm	2.760		

Skrūvgriezis 1000V PH

STANLEY.



ARTIKULS	CENA
300930 - PH0×75mm	4.820
300931 - PH1×100mm	4.530
300932 - PH2×125mm	5.140

Skrūvgriezis PH

MODECO



ARTIKULS	CENA
309724 - PH0×60mm	1.400
309722 - PH1×80mm	2.400
309723 - PH2×100mm	3.200
309726 - PH3×150mm	4.500

Skrūvgriezis PZ

MODECO



ARTIKULS	CENA
309735 - PZ0×60mm	1.400
309736 - PZ1×80mm	2.400
309737 - PZ2×100mm	3.200
309738 - PZ3×150mm	4.500

Skrūvgriezis 1000V PZ

STANLEY.



ARTIKULS	CENA
300935 - PZ0×75mm	4.860
300936 - PZ1×100mm	4.680
300937 - PZ2×125mm	5.140

"T" veida skrūvgriezis ar tarkšķi + 16 uzgāji + 6 mucināš

MODECO



ARTIKULS	CENA
309211 -	11.400

"T" veida skrūvgriezis + 21 uzgālis

MODECO



ARTIKULS	CENA
309741 -	3.980

Precīzo skrūvgriežu komplekts (6 gab.)

STANLEY.



ARTIKULS	CENA
300491 -	7.140

Regulējams skrūvgriezis ar tarkšķi + 13 uzgāji

MODECO



ARTIKULS	CENA
309210 -	7.300

Skrūvgriezis ar sprūdratu + 10 uzgāji

STANLEY.



ARTIKULS	CENA
300488 -	33.850

Skrūvgriezis ar tarkšķi + 10 uzgāji

STANLEY.



ARTIKULS	CENA
300459 -	20.850

Skrūvgriezis + 34 uzgāji

STANLEY.



ARTIKULS	CENA
300490 -	10.250

Skrūvgriezis + 6 uzgāji

STANLEY.



ARTIKULS	CENA
300489 -	8.100

Cena norādīta ar PVN

**Elektriskā sprieguma indikators
190mm (125-250V)**



ARTIKULS CENA
286635 - 125-250V 0.950

**Elektriskā sprieguma indikators
(70-250V)**

MODECO



ARTIKULS CENA
286638 - 70-250V 2.700

**Elektriskā sprieguma indikators
140mm (6-24V)**

MODECO



ARTIKULS CENA
286639 - 6-24V 0.990

**Seškantu īso atslēgu komplekts
(9 gab. - 1.5,2,2.5,3,4,5,6,8,10)**



ARTIKULS CENA
286390 - 3.200

**Lodveida un taisno seškantu īso atslēgu
kmp. (9 gab. - 1.5,2,2.5,3,4,5,6,8,10)**



ARTIKULS CENA
309538 - 4.650

**TORX īso atslēgu komplekts (9 gab. -
T10,T15,T20,T25,T27,T30, T40,T45,T50)**



ARTIKULS CENA
309542 - 4.450

**Seškantu garo atslēgu komplekts
(9 gab. - 1.5,2,2.5,3,4,5,6,8,10)**



ARTIKULS CENA
286394 - 8.100

**Lodveida un taisno seškantu garo atslēgu
kmp. (9 gab. - 1.5,2,2.5,3,4,5,6,8,10)**



ARTIKULS CENA
309541 - 6.360

**TORX garo atslēgu komplekts (9 gab. -
T10,T15,T20,T25,T27,T30, T40,T45,T50)**



ARTIKULS CENA
309543 - 8.600

Seškantu atslēga CrV



ARTIKULS	CENA	ARTIKULS	CENA	ARTIKULS	CENA
280207 - 4mm	0.380	280214 - 8mm	1.000	280225 - 14mm	2.650
280209 - 5mm	0.510	280218 - 10mm	1.350	280226 - 17mm	4.300
280211 - 6mm	0.750	280221 - 12mm	1.840	280227 - 19mm	5.000
280213 - 7mm	0.900	280223 - 13mm	2.250		

**Atslēgu komplekts
(6 gab. 6-17mm)**

MODECO



ARTIKULS CENA
309787 - 8.200

**Atslēgu komplekts
(8 gab. 6-22mm)**

MODECO



ARTIKULS CENA
309788 - 15.750

**Atslēgu komplekts
(10 gab. 6-32mm)**

MODECO



ARTIKULS CENA
309789 - 25.700

Atslēga			
			
ARTIKULS	CENA	ARTIKULS	CENA
284000 - 6mm	0.970	284011 - 17mm	2.200
284001 - 7mm	1.050	284012 - 18mm	2.470
284002 - 8mm	1.200	284013 - 19mm	2.770
284003 - 9mm	1.200	284014 - 20mm	3.090
284004 - 10mm	1.280	284015 - 21mm	3.270
284005 - 11mm	1.320	284016 - 22mm	3.410
284006 - 12mm	1.380	284017 - 23mm	4.070
284007 - 13mm	1.500	284018 - 24mm	4.590
284008 - 14mm	1.540	284019 - 27mm	6.490
284009 - 15mm	1.730	284020 - 30mm	7.950
284010 - 16mm	1.950	284021 - 32mm	8.690

Atslēga ar tirkšķi	
	
ARTIKULS	CENA
285602 - 8mm	5.390
285599 - 9mm	5.780
285603 - 10mm	6.020
285600 - 11mm	6.420
285604 - 12mm	6.570
285608 - 13mm	7.040
285605 - 14mm	7.590
285606 - 15mm	8.470
285609 - 17mm	9.530
285601 - 19mm	10.410

Atslēga			
			
ARTIKULS	CENA	ARTIKULS	CENA
309790 - 8-10mm	1.200	309795 - 22-24mm	4.600
309791 - 10-13mm	1.500	309796 - 24-27mm	5.000
309792 - 13-17mm	2.000	309797 - 27-30mm	7.370
309793 - 17-19mm	3.050	309798 - 30-32mm	8.770
309794 - 19-22mm	3.740		

Stellatslēga	
	
ARTIKULS	CENA
284058 - 0-20mm	4.580
284059 - 0-24mm	6.200
284060 - 0-30mm	8.280
284061 - 0-36mm	10.780

Tirkšķatslēga 1/2 un 3/8	
	
ARTIKULS	CENA
286661 - 140mm 3/4 + 1/2	7.800

Tirkšķatslēga 1/2	
STANLEY. 	
ARTIKULS	CENA
300950 - 254mm 1/2	28.600

Tirkšķatslēga	
MODECO 	
ARTIKULS	CENA
309555 - 160mm 1/4	6.370
309556 - 210mm 3/8	9.950
309557 - 260mm 1/2	11.000

Tirkšķatstlēga 1/4 + 10 mucīņas (4,5,5,5,6,7,8,10,11,13mm)	
STANLEY. 	
ARTIKULS	CENA
300955 -	26.440

Tirkšķatstlēga 1/2 + 9 mucīņas (10,12,13,14,15,16,17,19,22mm)	
MODECO 	
ARTIKULS	CENA
309531 -	30.000

Dinamometriskā atslēga 1/2 42-210Nm + pagarinātājs 125mm + adapteris 3/8	
MODECO 	
ARTIKULS	CENA
309565 - 570mm 1/2	42.000

Seškantu mucīņa 1/2 CrV



ARTIKULS	CENA	ARTIKULS	CENA	ARTIKULS	CENA
284608 - 8mm	1.340	284615 - 15mm	1.530	284622 - 22mm	2.170
284609 - 9mm	1.340	284616 - 16mm	1.530	284623 - 23mm	2.330
284610 - 10mm	1.400	284617 - 17mm	1.730	284624 - 24mm	2.420
284611 - 11mm	1.400	284618 - 18mm	1.730	284627 - 27mm	3.310
284612 - 12mm	1.400	284619 - 19mm	1.730	284630 - 30mm	3.860
284613 - 13mm	1.530	284620 - 20mm	2.000	284632 - 32mm	4.190
284614 - 14mm	1.530	284621 - 21mm	2.000		

Seškantu mucīņa 1/2 pagarināta (76mm) CrV



ARTIKULS	CENA	ARTIKULS	CENA
284658 - 8mm	2.790	284668 - 18mm	2.950
284659 - 9mm	2.790	284669 - 19mm	3.080
284660 - 10mm	2.790	284670 - 20mm	3.310
284661 - 11mm	2.790	284671 - 21mm	3.760
284662 - 12mm	2.790	284672 - 22mm	3.990
284663 - 13mm	2.790	284673 - 23mm	4.280
284664 - 14mm	2.790	284674 - 24mm	4.400
284665 - 15mm	2.870	284675 - 27mm	5.750
284666 - 16mm	2.870	284676 - 30mm	6.760
284667 - 17mm	2.870	284677 - 32mm	6.880

Seškantu mucīņa 1/4 pagarināta (50mm) CrV



ARTIKULS	CENA
284642 - 4mm	1.250
284643 - 5mm	1.250
284644 - 6mm	1.250
284645 - 7mm	1.250
284646 - 8mm	1.250
284647 - 9mm	1.250
284648 - 10mm	1.250
284649 - 11mm	1.300
284650 - 12mm	1.380
284651 - 13mm	1.450

Adapteris CrV



ARTIKULS	CENA
309535 - 3/8 uz 1/4	1.180
309536 - 3/8 uz 1/2	1.900
309537 - 1/2 uz 3/8	2.350

Pagarinātājs 1/2 CrV



ARTIKULS	CENA
309561 - 1/2 75mm	3.220
309562 - 1/2 125mm	3.540
309563 - 1/2 250mm	6.130

Pagarinātājs lokans CrV



ARTIKULS	CENA
284585 - 1/4 140mm	2.660
284586 - 1/2 190mm	11.000

Muciņu kardāns 1/2 CrV



ARTIKULS	CENA
309545 - 1/2 80mm	5.190

T-veida atslēga 1/2 CrV



ARTIKULS	CENA
309569 - 1/2 250mm	6.580

Muciņu atslēga CrV



ARTIKULS	CENA
309559 - 1/4 125mm	6.520
309558 - 1/2 375mm	14.180

Āmurs ar koka kātu	
	
ARTIKULS	CENA
285359 - 100g	1.940
285360 - 200g	2.380
285361 - 300g	3.000
285362 - 500g	3.500
285363 - 800g	4.950
285364 - 1000g	6.000
285365 - 1500g	7.300
285366 - 2000g	8.900
285367 - 3000g	15.650
285368 - 4000g	21.000
285369 - 5000g	26.200

Āmurs ar aizsargstīpu	
	
ARTIKULS	CENA
283510 - 1500g	11.580

Koka āmurs	
	
ARTIKULS	CENA
286525 - 410g	2.950

Koka kāts āmuram	
	
ARTIKULS	CENA
286566 - 32cm	0.470
286567 - 36cm	0.530
286568 - 40cm	0.600
286569 - 50cm	0.910
286570 - 60cm	1.500
286571 - 70cm	1.710
286572 - 80cm	2.020
286573 - 90cm	2.500

Āmurs ar stiklašķiedras kātu	
	
ARTIKULS	CENA
283521 - 200g	3.100
283522 - 300g	3.640
283523 - 500g	4.900
283524 - 800g	5.840
283525 - 1000g	6.700
283526 - 1500g	8.900

Mūrnieka āmurs ar koka kātu	
	
ARTIKULS	CENA
309687 - 600g	6.350

Divpusējs gumijas un plastikas āmurs	
	
ARTIKULS	CENA
286530 - 400g	2.920

Gumijas āmurs	
	
ARTIKULS	CENA
286534 - 450g	2.500
309646 - 800g	4.620

Gumijas āmurs	
	
ARTIKULS	CENA
286540 - 800g	4.740

Āmurs naglu vilcējs ar stiklašķiedras kātu	
	
ARTIKULS	CENA
309660 - 450g	6.900

Mūrnieka āmurs ar stiklašķiedras kātu	
	
ARTIKULS	CENA
309689 - 600g	6.800

Celtnieka āmurs ar stiklašķiedras kātu	
	
ARTIKULS	CENA
309685 - 600g	6.600

Mūrnieka āmurs ar stiklašķiedras kātu	
	
ARTIKULS	CENA
309686 - 600g	7.100

Veseris	
	
ARTIKULS	CENA
283500 - 5000g	20.630
283502 - 8000g	30.580

Lauznis ar ovālo profilu	
	
ARTIKULS	CENA
309630 - 300mm	3.700
309631 - 450mm	7.800
309632 - 600mm	9.500
309633 - 750mm	10.950
309634 - 900mm	13.500

Lauznis	
	
ARTIKULS	CENA
286546 - 1000mm	16.000
286547 - 1500mm	21.000

Kalts kokam	
	
ARTIKULS	CENA
285297 - 10mm	2.990
285298 - 12mm	3.200
285299 - 16mm	3.200
285300 - 18mm	3.450
285301 - 20mm	3.690
285302 - 22mm	3.740
285304 - 25mm	3.780
285306 - 32mm	4.240
285308 - 38mm	4.510

Plakanais cirtnis SDS+	
	
ARTIKULS	CENA
286496 - 20x250mm	2.200
286497 - 40x250mm	2.470

Cirtnis atslēdznieka	
	
ARTIKULS	CENA
285591 - 200mm	4.350
285592 - 250mm	5.410

Cirtnis	
	
ARTIKULS	CENA
309621 - 300mm	3.270
309625 - 400mm	3.950
309627 - 500mm	5.150

Punktusītis ar maināmo galu	
STANLEY	
	
ARTIKULS	CENA
300645 - 76mm	8.000

Caurumsišu komplekts (6 gab.)	
STANLEY	
	
ARTIKULS	CENA
300643 - 6 gab.	11.400

Punktveida cirtnis SDS+	
	
ARTIKULS	CENA
286495 - 250mm	2.290

Ķieģeļu kalts	
STANLEY	
	
ARTIKULS	CENA
300825 - 45x215mm	7.520
300826 - 100x215mm	10.580

Dornis	
	
ARTIKULS	CENA
286490 - 6.3x100mm	0.950
286491 - 9.4x127.5mm	1.270
286492 - 12.7x152mm	1.750

Atzīmētājs	
	
ARTIKULS	CENA
286493 - 140mm	1.730

Caurumsišu komplekts (9 gab.)	
	
ARTIKULS	CENA
286576 - 9 gab.	7.500

Pusapaļš cirtnis SDS+	
	
ARTIKULS	CENA
286498 - 250mm	2.850

Plakanknaible



ARTIKULS	CENA
309192 - 160mm	3.750
309194 - 200mm	5.700

Sānu knaible



ARTIKULS	CENA
309195 - 160mm	3.340
309196 - 180mm	4.240

Taisnās metāla grieznes (metāls 0.7-1.2mm)



ARTIKULS	CENA
309391 - 250mm	9.400

Telefona knaibles līkās



ARTIKULS	CENA
309198 - 160mm	3.400

Spicās knaibles



ARTIKULS	CENA
309199 - 160mm	3.500

Taisnās metāla grieznes (metāls 0.7-1.2mm)

STANLEY



ARTIKULS	CENA
300594 - 250mm	15.400
300597 - 300mm	16.700

Telefona plakanknaibles



ARTIKULS	CENA
309197 - 160mm	3.450

Regulējamas knaibles



ARTIKULS	CENA
309200 - 250mm	5.900

Kreisās metāla grieznes (metāls 0.7-1.2mm)

STANLEY



ARTIKULS	CENA
300593 - 250mm	15.400

Knaibles ārējiem fiksācijas gredzeniem līkās



ARTIKULS	CENA
309189 - 150mm (8-30)	2.850
309190 - 200mm (30-60)	4.100

Knaibles ārējiem fiksācijas gredzeniem taisnās



ARTIKULS	CENA
309186 - 150mm (8-30)	2.850
309187 - 200mm (30-60)	4.100

Labās metāla grieznes (metāls 0.7-1.2mm)

STANLEY



ARTIKULS	CENA
300595 - 250mm	15.400

Roratslēga



ARTIKULS	CENA
309204 - 315mm	17.060
309205 - 425mm	25.500
309206 - 555mm	39.930

Asknaible



ARTIKULS	CENA
309668 - 160mm	4.270
309670 - 200mm	5.060
309673 - 300mm	8.400

Lielās knaibles



ARTIKULS	CENA
309676 - 450mm (6mm)	16.000
309677 - 600mm (8mm)	22.000
300678 - 750mm (10mm)	31.390
300679 - 900mm (12mm)	40.640

Metāla nazis ar nolaužamu asmeni

MODECO



ARTIKULS	CENA
309752 - 9mm	1.800
309753 - 18mm	3.100

Nazis SM ar nolaužamu asmeni

STANLEY



ARTIKULS	CENA
300469 - 9mm	1.650
300471 - 18mm	2.650

Naža asmenis ar laužamiem segmentiem (10 gab.)

MODECO



ARTIKULS	CENA
309757 - 9mm	0.800
309756 - 18mm	1.100

Nazis ar nolaužamu asmeni

MODECO



ARTIKULS	CENA
309751 - 18mm	1.900

Nazis ar nolaužamu asmeni



ARTIKULS	CENA
280115 - 18mm	1.400

Naža asmenis ar laužamiem segmentiem (10 gab.)

STANLEY



ARTIKULS	CENA
300473 - 9mm	2.400
300472 - 18mm	3.000

Nazis FATMAX ar fiksētu asmeni

STANLEY



ARTIKULS	CENA
300506 - 180mm	12.700

Nazis 199E ar fiksētu asmeni

STANLEY



ARTIKULS	CENA
300463 - 140mm	5.260

Naža asmenis ar laužamiem segmentiem (10 gab.)



ARTIKULS	CENA
306029 - 18mm	2.300

1991 asmens (vispārējā pielietojuma asmens, piem. papīra, kartona un ādas izstrādājumi)

STANLEY



ARTIKULS	CENA
300524 -	1.200

1992 asmens (Paredzēts prasīgiem darbiem, kam nepieciešams stingrāks asmens)

STANLEY



ARTIKULS	CENA
300468 -	1.300

Nazis minerālvatei 280mm

HARDY WORKING TOOLS



ARTIKULS	CENA
285025 - 280mm	5.900

1996 asmens (Piemērots dažādu lokšņu materiālu griešanai)

STANLEY



ARTIKULS	CENA
300467 -	1.800

Nažu asmeņi koka un metāla zāģēšanai

STANLEY



ARTIKULS	CENA
300486 - 190mm kokam	3.920
300484 - 190mm metālam	3.450

Nazis minerālvatei 340mm

MODECO



ARTIKULS	CENA
309765 - 340mm	9.900

Zāģis OPP (koks, saplāksnis)

STANLEY



ARTIKULS	CENA	ARTIKULS	CENA
300682 - 380mm×8z	11.980	300686 - 380mm×11z	13.100
300683 - 450mm×8z	12.860	300687 - 450mm×11z	13.950
300684 - 500mm×8z	13.880	300688 - 500mm×11z	14.500
300685 - 550mm×8z	14.380		

Zāģis GOLD LINE (koks, saplāksnis)

MODECO



ARTIKULS	CENA	ARTIKULS	CENA
309581 - 400mm×9z	5.250	309583 - 500mm×9z	6.280

Zāģis ALIGATOR (koks, saplāksnis)



ARTIKULS	CENA	ARTIKULS	CENA
286861 - 400mm×7z	6.550	286863 - 500mm×7z	8.300

Reģipša zāģis (reģipsis, koks, PVC)

MODECO



ARTIKULS	CENA
309585 - 155mm×8z	4.600

Caurumu zāģis (koks, saplāksnis)



ARTIKULS	CENA
286855 - 300mm×7z	5.700

Zāģis metālam

MODECO



ARTIKULS	CENA
309570 - 300mm	6.990

Zāģis metālam



ARTIKULS	CENA
286858 - 300mm	3.700

Cirvis ar koka kātu

MODECO



ARTIKULS	CENA
309554 - 600g	8.240
309553 - 800g	9.200
309550 - 1000g	9.950
309551 - 1250g	15.430
309552 - 1500g	16.900

Grīdas dēļu zāģis FATMAX (koks, saplāksnis)

STANLEY



ARTIKULS	CENA
300695 - 350mm×13z	15.600

Plastmasas šablons zaģēšanai



ARTIKULS	CENA
286823 - 212×42mm	1.500
286824 - 233×53mm	1.500
286825 - 250×65mm	1.650
286826 - 295×80mm	2.990
286827 - 320×120mm	5.520

Lenķzāģis 550mm
(15°, 22.5°, 30°, 36°, 45°, 90°)

MODECO



ARTIKULS	CENA
309590 - 550mm	47.400

Krīta līnija OPP 30m

STANLEY



ARTIKULS	CENA
300802 - 30m	9.000

Krīta līnija 15m



ARTIKULS	CENA
309480 - 15m	1.830

Krīta pulveris

STANLEY



ARTIKULS	CENA
300800 - 115g zils	1.900
300799 - 115g sarkans	1.900

Zīmulis



ARTIKULS	CENA
309773 - 180mm	0.200
309774 - 240mm	0.420

Zīmulis galdnieka

MODECO



ARTIKULS	CENA
309776 - 180mm	0.240
309775 - 240mm	0.400

Vaska krītiņš

MODECO



ARTIKULS	CENA
310290 - sarkans	0.600
310291 - dzeltens	0.600
310292 - zaļš	0.600
310293 - zils	0.600

Zīmulis stiklam

MODECO



ARTIKULS	CENA
286952 - 240mm	1.300

Zīmulis mūrnieka

MODECO



ARTIKULS	CENA
286951 - 240mm	0.850

Marķieris permanentais, balts, apaļš Ø0.7mm

centropen



ARTIKULS	CENA
318174 - balts	3.400

Marķieris permanentais, apaļš Ø1mm (2 gab.)

STANLEY



ARTIKULS	CENA
300515 - melns	2.550

Marķieris permanentais, apaļš (2 gab.)

STANLEY



ARTIKULS	CENA
300513 - melns	4.600

Marķieris permanentais, melns, apaļš Ø2.5mm

centropen



ARTIKULS	CENA
318164 - melns	0.780

Marķieris permanentais, melns, apaļš Ø1mm

centropen



ARTIKULS	CENA
318184 - melns	0.550

Marķieris permanentais, melns, šķeltis Ø2-5mm

centropen



ARTIKULS	CENA
318165 - melns	0.840

Marķieris permanentais, melns, apaļš Ø2.5mm

centropen



ARTIKULS	CENA
318182 - melns	0.780

Dimanta disks 22.23mm (betons, akmens, ķieģeļi, bruģakmens)



ARTIKULS	CENA
309121 - 125mm	6.400
309123 - 230mm	18.000

Dimanta disks 22.23mm (betons, akmens, ķieģeļi, bruģakmens)



ARTIKULS	CENA
309116 - 125mm	4.650
309118 - 230mm	12.980

Dimanta disks 22.23mm (flīzes, ķieģeļi)



ARTIKULS	CENA
309111 - 125mm	4.800
309113 - 230mm	14.000

Cirkulārā zāgripa kokam



ARTIKULS	CENA	ARTIKULS	CENA
324700 - 130x20x1.4mm/24z	3.910	324710 - 200x30x1.6mm/40z	10.550
324701 - 140x20x1.4mm/24z	4.180	324711 - 203x30x1.6mm/30z	10.700
324702 - 152x20x1.4mm/30z	4.200	324712 - 250x30x2.0mm/24z	15.440
324703 - 160x20x1.4mm/24z	4.600	324713 - 250x30x2.0mm/60z	15.630
324704 - 160x20x1.4mm/36z	4.620	324714 - 300x30x2.0mm/40z	21.520
324705 - 170x30x1.4mm/60z	5.000	324715 - 350x30x2.2mm/40z	29.730
324706 - 180x30x1.4mm/24z	5.050	324716 - 350x30x2.2mm/40z	33.340
324707 - 184x30x1.4mm/40z	5.660	324717 - 400x30x2.5mm/48z	37.060
324708 - 190x30x1.4mm/40z	6.130	324718 - 400x30x2.5mm/60z	40.450
324709 - 200x30x1.6mm/24z	10.020	324719 - 450x30x2.5mm/60z	55.650

Cirkulārā zāgripa kokam, metālam



ARTIKULS	CENA
324740 - 160x20x1.4mm/40z	7.870
324741 - 184x30x1.4mm/56z	11.570

Ķēdes disks kokam 22mm



ARTIKULS	CENA
309597 - 125mm	26.300

LUGA griezējdiskus STEEL taisns 22.23mm



ARTIKULS	CENA
304511 - 125x1.0mm	0.480
304512 - 125x1.2mm	0.480
304514 - 125x1.6mm	0.520
304515 - 230x2.0mm	1.460

RASTA griezējdiskus INOX taisns 22.23mm



ARTIKULS	CENA
300012 - 125x1.0mm	1.300
300017 - 125x1.2mm	1.640
300021 - 125x1.6mm	1.640
300031 - 230x1.9mm	2.900

RASTA griezējdiskus STONE taisns 22.23mm



ARTIKULS	CENA
300046 - 125x2.5mm	1.650

DRONCO griezējdiskus SPECIAL INOX taisns 22.23mm



ARTIKULS	CENA
304863 - 125x1.0mm	0.960
304882 - 230x2.0mm	1.900

DRONCO griezējdiskus PERFECT INOX taisns 22.23mm



ARTIKULS	CENA
304862 - 125x1.0mm	0.890
304871 - 125x1.6mm	0.890

MOST griezējdiskus INOX taisns 22.23mm



ARTIKULS	CENA
307320 - 125x1.0mm	1.120
307425 - 230x1.9mm	3.100

Cena norādīta ar PVN

MOST slīpešanas disks STEEL 22.23mm



ARTIKULS	CENA
307300 - 125×6.8mm	1.990
307316 - 230×6.0mm	4.350

RASTA slīpešanas disks STEEL 22.23mm



ARTIKULS	CENA
300076 - 125×6.0mm	2.160
300084 - 230×6.0mm	4.400

Dimanta kausriņa betonam 22.23mm (betons, ķieģelis, bruģakmens)



ARTIKULS	CENA
309108 - 125mm	32.980

Asināšanas ripa



ARTIKULS	CENA	ARTIKULS	CENA
282280 - 125×15mm Coarse	2.430	282283 - 150×15mm Fine	3.050
282281 - 125×15mm Fine	2.430	282284 - 200×20mm Coarse	6.720
282282 - 150×15mm Coarse	3.050	282285 - 200×20mm Fine	6.720

MOST ziedlapas disks INOX 22.23mm



ARTIKULS	CENA
307301 - 125mm×P40	2.250
307302 - 125mm×P60	2.250
307303 - 125mm×P80	2.250
307305 - 125mm×P120	2.450

Diskveida birste ar vītņi M14 tērauda



ARTIKULS	CENA
286130 - 100mm	2.450
286131 - 115mm	2.720
286133 - 125mm	3.060

Diskveida birste ar vītņi M14 tērauda (11000 apgr./min.)



ARTIKULS	CENA
286110 - 100mm	2.880
286111 - 115mm	3.200
286113 - 125mm	3.710

Diskveida birste ar vītņi M14 misiņa (8500 apgr./min.)



ARTIKULS	CENA
286140 - 100mm	2.450
286142 - 115mm	2.720
286144 - 125mm	3.060

Koniskā birste ar vītņi M14 misiņa



ARTIKULS	CENA
286117 - 75mm	2.100
286119 - 100mm	3.120
286121 - 125mm	4.440

Koniskā birste ar vītņi M14 tērauda



ARTIKULS	CENA
286149 - 75mm	2.100
286151 - 100mm	3.120
286154 - 125mm	4.440

Koniskā birste ar vītņi M14 tērauda



ARTIKULS	CENA
286101 - 75mm	2.500
286103 - 100mm	3.880
286105 - 125mm	5.460

Smilšaudeklis 115mm



ARTIKULS	CENA/m	ARTIKULS	CENA/m	ARTIKULS	CENA/m
306902 - N40	0.850	306905 - N100	0.700	306908 - N180	0.700
306903 - N60	0.760	306906 - N120	0.700	306910 - N240	0.700
306904 - N80	0.760	306907 - N150	0.700	306912 - N320	0.700

Smilšpapīra turētājs



ARTIKULS	CENA
287228 - 105x212mm	2.550

Smilšpapīra turētājs



ARTIKULS	CENA
287229 - 105x225	1.700

Smilšpapīra turētājs



ARTIKULS	CENA
287230 - 105x210	1.490

Vīturbju komplekts (3 gab.)

MODECO



ARTIKULS	CENA
309045 - M3	3.700
309046 - M4	3.920
309047 - M5	4.180
309048 - M6	4.200
309049 - M8	5.850
309050 - M10	10.250
309051 - M12	12.400
309052 - M14	16.460
309053 - M16	20.300
309054 - M20	29.840

Vītņgriezis



ARTIKULS	CENA
301643 - M3	5.100
301645 - M4	5.100
301647 - M5	5.100
301648 - M6	5.800
301650 - M8	6.260
301653 - M10	6.950
301655 - M12	8.770
301658 - M14	9.330
301660 - M16	13.290
301662 - M20	14.360

Slīpšvamme

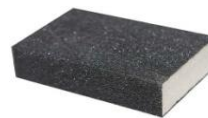

ARTIKULS	CENA
285399 - N60	0.700
285400 - N80	0.700
285401 - N100	0.700
285402 - N120	0.700
285403 - N150	0.700

Vīturbju turētājs

MODECO



ARTIKULS	CENA
309061 - M4-M8	6.250
309062 - M9-M12	8.200
309063 - M13-M18	24.220

Vītņgriežu turētājs

MODECO



ARTIKULS	CENA
301665 - M4-M6	6.000
301666 - M8	6.530
301667 - M10	7.000
301668 - M12-M14	8.470

Stikla griezējs JOBO (3-10mm)





ARTIKULS	CENA
286632 -	3.390

Stikla griezējs SILBERSCHNITT (3-10mm)



ARTIKULS	CENA
286633 -	8.000

Vīle apaļa	
	
ARTIKULS	CENA
286460 - 200mm	1.800
286464 - 250mm	3.780

Vīle pusapaļa	
	
ARTIKULS	CENA
286459 - 200mm	2.300
286465 - 250mm	4.200

Slīplenta 75x457	
	
ARTIKULS	CENA
303091 - N40	1.140
303093 - N60	1.140
303094 - N80	1.140
303095 - N100	1.140
303096 - N120	1.140
303097 - N150	1.140
303098 - N180	1.140

Vīle plakana	
	
ARTIKULS	CENA
286458 - 200mm	1.950
286463 - 250mm	3.800

Vīle trīstūra	
	
ARTIKULS	CENA
286462 - 200mm	2.200
286466 - 250mm	4.070

Slīplenta 75x533	
	
ARTIKULS	CENA
303105 - N40	1.200
303107 - N60	1.200
303108 - N80	1.200
303109 - N100	1.200
303110 - N120	1.200
303111 - N150	1.200
303113 - N180	1.200

Skrāpējvīle	
STANLEY.	
	
ARTIKULS	CENA
300510 - 140mm	7.180

Skrāpējvīles asmens	
STANLEY.	
	
ARTIKULS	CENA
300512 - 140mm	2.390
300509 - 250mm	2.800

Slīplenta 100x610	
	
ARTIKULS	CENA
303125 - N40	1.400
303126 - N60	1.400
303127 - N80	1.400
303128 - N100	1.400
303129 - N120	1.400
303130 - N150	1.400
303131 - N180	1.400

Skrāpējvīle	
STANLEY.	
	
ARTIKULS	CENA
300497 - 140mm	5.930
300498 - 250mm	7.180

Skrāpējvīles asmens ar izliekumu	
STANLEY.	
	
ARTIKULS	CENA
300500 - 250mm	4.500

Abrazīvais siets 105x270mm	
	
ARTIKULS	CENA
306981 - N60	0.200
306983 - N100	0.200
306984 - N120	0.200
306985 - N150	0.200

Rokas birste (tērauda sari)	
	
ARTIKULS	CENA
286790 - 3 rindu	0.620
286791 - 4 rindu	0.690
286792 - 5 rindu	0.790
286793 - 6 rindu	0.870

Rokas birste (tērauda sari ar misiņa pārklājumu)	
	
ARTIKULS	CENA
285201 - 240mm	1.000

Urbis metālam DIN 338 HSS-G, CYL



ARTIKULS	CENA
HSS-G - 1.0×12/34mm	0.680
HSS-G - 1.5×18/40mm	0.540
HSS-G - 2.0×24/49mm	0.540
HSS-G - 2.5×30/57mm	0.580
HSS-G - 3.0×33/61mm	0.580
HSS-G - 3.3×36/65mm	0.640
HSS-G - 3.5×39/70mm	0.670
HSS-G - 4.0×43/75mm	0.750
HSS-G - 4.2×43/75mm	0.750
HSS-G - 4.5×47/80mm	0.830
HSS-G - 5.0×52/86mm	0.980
HSS-G - 5.5×57/93mm	1.200
HSS-G - 6.0×57/93mm	1.250
HSS-G - 6.5×63/101mm	1.490
HSS-G - 7.0×69/109mm	1.790
HSS-G - 7.5×69/109mm	1.790
HSS-G - 8.0×75/117mm	2.200
HSS-G - 8.5×75/117mm	2.310
HSS-G - 9.0×81/125mm	2.840
HSS-G - 9.5×81/125mm	3.300
HSS-G - 10.0×87/133mm	3.800
HSS-G - 10.5×87/133mm	4.230
HSS-G - 11.0×94/142mm	4.900
HSS-G - 11.5×94/142mm	5.120
HSS-G - 12.0×101/151mm	5.600
HSS-G - 12.5×101/151mm	6.000
HSS-G - 13.0×101/151mm	6.800

Urbis metālam DIN 338 HSS-R, CYL



ARTIKULS	CENA
HSS-R - 1.0×12/34mm	0.280
HSS-R - 1.5×18/40mm	0.280
HSS-R - 2.0×24/49mm	0.280
HSS-R - 2.5×30/57mm	0.310
HSS-R - 3.0×33/61mm	0.330
HSS-R - 3.3×36/65mm	0.360
HSS-R - 3.5×39/70mm	0.420
HSS-R - 4.0×43/75mm	0.460
HSS-R - 4.2×43/75mm	0.460
HSS-R - 4.5×47/80mm	0.510
HSS-R - 5.0×52/86mm	0.620
HSS-R - 5.5×57/93mm	0.700
HSS-R - 6.0×57/93mm	0.730
HSS-R - 6.5×63/101mm	0.900
HSS-R - 7.0×69/109mm	1.000
HSS-R - 7.5×69/109mm	1.130
HSS-R - 8.0×75/117mm	1.260
HSS-R - 8.5×75/117mm	1.290
HSS-R - 9.0×81/125mm	1.420
HSS-R - 9.5×81/125mm	1.540
HSS-R - 10.0×87/133mm	1.790
HSS-R - 10.5×87/133mm	2.150
HSS-R - 11.0×94/142mm	2.500
HSS-R - 11.5×94/142mm	2.600
HSS-R - 12.0×101/151mm	2.920
HSS-R - 12.5×101/151mm	3.000
HSS-R - 13.0×101/151mm	3.200

Spirālurbis kokam, HEX



ARTIKULS	CENA
290500 - 6×250mm	3.050
290501 - 6×450mm	4.800
290502 - 8×250mm	3.050
290503 - 8×450mm	4.800
290504 - 10×250mm	3.050
290505 - 10×450mm	5.000
290506 - 12×250mm	3.450
290507 - 12×450mm	5.300
290508 - 12×600mm	9.340
290509 - 14×250mm	3.450
290510 - 14×450mm	5.900
290511 - 14×600mm	10.100
290512 - 16×250mm	3.850
290513 - 16×450mm	7.100
290514 - 16×600mm	10.600
290515 - 18×250mm	4.500
290516 - 18×450mm	8.100
290517 - 18×600mm	12.640
290518 - 20×250mm	4.970
290519 - 20×450mm	10.120
290520 - 20×600mm	13.130
290521 - 22×250mm	5.500
290522 - 22×450mm	10.600
290523 - 22×600mm	13.700
290524 - 24×250mm	6.320
290525 - 24×450mm	14.660
290526 - 24×600mm	19.200

Urbis metālam DIN 338 HSS-Co, CYL



ARTIKULS	CENA
HSS-Co - 1.0×12/34mm	2.330
HSS-Co - 1.5×18/40mm	1.970
HSS-Co - 2.0×24/49mm	1.740
HSS-Co - 2.5×30/57mm	1.800
HSS-Co - 3.0×33/61mm	1.870
HSS-Co - 3.5×39/70mm	2.230
HSS-Co - 4.0×43/75mm	2.400
HSS-Co - 4.5×47/80mm	2.630
HSS-Co - 5.0×52/86mm	2.850
HSS-Co - 6.0×57/93mm	3.780
HSS-Co - 7.0×69/109mm	4.420
HSS-Co - 8.0×75/117mm	5.600
HSS-Co - 9.0×81/125mm	7.100
HSS-Co - 10.0×87/133mm	8.420
HSS-Co - 11.0×94/140mm	13.120
HSS-Co - 12.0×101/151mm	15.900
HSS-Co - 13.0×101/151mm	21.440

Spalvurbis kokam 330s, 1/4HEX



ARTIKULS	CENA
330s - 6×152mm	2.650
330s - 8×152mm	2.650
330s - 10×152mm	2.650
330s - 12×152mm	2.720
330s - 14×152mm	2.910
330s - 16×152mm	3.020
330s - 18×152mm	3.100
330s - 20×152mm	3.220
330s - 22×152mm	3.260
330s - 24×152mm	3.430
330s - 25×152mm	3.430
330s - 28×152mm	3.880
330s - 30×152mm	4.130
330s - 32×152mm	4.480
330s - 35×152mm	5.150
330s - 38×152mm	5.620
330s - 40×152mm	6.200

Dubulturbis (kniežu urbis)



ARTIKULS	CENA
290550 - 3.3mm	0.700
300434 - 3.3mm	0.900
300435 - 4.1mm	1.150
290552 - 4.2mm	0.900
300436 - 4.8mm	1.460

Daudzpakāpju urbju komplekts
(4-12mm, 4-20mm, 4-32mm)

ARTIKULS	CENA
286770 -	15.900

Urbis betonam, SDS+



ARTIKULS	CENA
290002 - 5x50/110mm	2.560
290003 - 5x100/160mm	2.730
290004 - 6x50/110mm	2.530
290005 - 6x100/160mm	2.750
290006 - 6x150/210mm	4.390
290007 - 6x200/260mm	4.900
290008 - 8x50/110mm	3.300
290009 - 8x100/160mm	3.390
290010 - 8x150/210mm	4.050
290011 - 8x200/260mm	4.560
290012 - 8x400/460mm	11.200
290015 - 10x100/160mm	4.000
290016 - 10x150/210mm	4.610
290017 - 10x200/260mm	5.680
290018 - 10x250/310mm	6.470
290019 - 10x400/460mm	9.480
290014 - 10x550/600mm	17.300
290020 - 12x100/160mm	4.320
290021 - 12x150/210mm	5.070
290022 - 12x200/260mm	6.470
290023 - 12x400/450mm	11.290
290024 - 12x550/600mm	18.460
290026 - 14x100/160mm	6.570
290027 - 14x150/200mm	8.040
290028 - 14x200/250mm	8.900
290029 - 14x250/300mm	9.480
290031 - 16x150/200mm	9.910
290032 - 16x200/250mm	12.310
290033 - 16x250/300mm	14.610
290034 - 16x400/450mm	19.240
290035 - 16x550/600mm	21.090
290036 - 18x150/200mm	16.590
290037 - 18x250/300mm	19.860
290038 - 18x400/450mm	21.020
290040 - 20x150/200mm	20.000
290041 - 20x250/300mm	22.840
290042 - 20x400/450mm	24.220
290043 - 20x550/600mm	31.550
290044 - 22x200/250mm	29.000
290048 - 22x400/450mm	38.350
290046 - 25x200/250mm	35.360
290045 - 25x400/450mm	45.900

Kroņurbju komplekts volframa (33, 53, 67, 83), SDS+



ARTIKULS	CENA
309422 - 33-83mm	21.500

Kroņurbju komplekts (51, 57, 67, 76, 88, 102), HEX



ARTIKULS	CENA
309408 - 51-102mm	9.950

Kroņurbju komplekts (19, 22, 29, 35, 38, 44, 51, 64), HEX



ARTIKULS	CENA
309409 - 19-64mm	8.000

Kroņurbis volframa



ARTIKULS	CENA
309425 - 33x65mm	2.600
309426 - 43x65mm	3.360
309427 - 53x65mm	3.890
309428 - 67x65mm	5.420
309429 - 73x65mm	5.610
309430 - 83x65mm	6.300

Kroņurbja turētājs 33-83mm



ARTIKULS	CENA
309423 -	3.450

Kroņurbja serdenis, HEX



ARTIKULS	CENA
309424 - 8x135mm	1.810

Urbis kokam 333s, CYL



ARTIKULS	CENA
333s - 3x30/60mm	1.730
333s - 4x43/75mm	1.730
333s - 5x50/85mm	1.890
333s - 6x52/90mm	1.940
333s - 6x200/250mm	3.990
333s - 7x68/110mm	2.090
333s - 8x75/120mm	2.350
333s - 8x200/250mm	5.230
333s - 9x78/125mm	2.600
333s - 10x80/130mm	2.750
333s - 10x200/250mm	6.180
333s - 11x90/140mm	2.900
333s - 12x100/150mm	2.960
333s - 12x200/250mm	6.680
333s - 13x100/150mm	3.410
333s - 14x105/160mm	4.170
333s - 14x200/250mm	7.610
333s - 15x105/170mm	4.220
333s - 16x115/180mm	4.630
333s - 16x200/250mm	8.540
333s - 18x120/190mm	9.450
333s - 18x200/250mm	11.700
333s - 20x130/200mm	12.160

Kroņurbis betonam, SDS+



ARTIKULS	CENA
309418 - 65x155mm HEX	8.600
309419 - 80x155mm HEX	11.850
309420 - 65x155mm SDS+	8.600
309421 - 80x155mm SDS+	11.850

Urbis stiklam, flīzēm, CYL



ARTIKULS	CENA
286800 - 4mm	2.770
286801 - 6mm	3.530
286802 - 8mm	3.980
286803 - 10mm	4.380

Līmeņrādis MODECO
(precizitāte: +/- 1.0mm/m)



ARTIKULS	CENA	ARTIKULS	CENA
309320 - 80cm	9.500	309322 - 120cm	12.550
309321 - 100cm	11.000	309324 - 200cm	22.600

Līmeņrādis STANLEY I-BEAM 180
(precizitāte: +/- 1.5mm/m)

STANLEY.



ARTIKULS	CENA	ARTIKULS	CENA
300608 - 40cm	10.900	300610 - 100cm	20.000
300609 - 60cm	15.500	300611 - 120cm	23.690

Līmeņrādis STANLEY FATMAX I-BEAM
(precizitāte: +/- 0.5mm/m)

STANLEY.



ARTIKULS	CENA	ARTIKULS	CENA
300612 - 60cm	20.800	300614 - 180cm	45.430
300613 - 120cm	30.630		

Līmeņrādis STANLEY FATMAX I-BEAM magnētisks
(precizitāte: +/- 0.5mm/m)

STANLEY.



ARTIKULS	CENA	ARTIKULS	CENA
300615 - 60cm	23.620	300617 - 200cm	49.500
300616 - 120cm	34.380		

Līmeņrādis STANLEY FATMAX
(precizitāte abām virsmām: +/- 0.5mm/m)

STANLEY.



ARTIKULS	CENA	ARTIKULS	CENA
300575 - 60cm	32.280	300578 - 180cm	61.540
300577 - 120cm	44.660		

Galdnieka stūrenis alumīnija



ARTIKULS	CENA
309237 - 250mm	4.400
309238 - 300mm	4.750
309239 - 350mm	5.480
309240 - 400mm	6.350

Galdnieka stūrenis tērauda



ARTIKULS	CENA
283925 - 300mm	1.300
283926 - 350mm	1.400
283927 - 400mm	2.250

Regulējams stūrenis alumīnija

MODECO



ARTIKULS	CENA
309248 - 350mm	22.450
309249 - 750mm	24.400

Jumiņa stūrenis tērauda
600x400mm



ARTIKULS	CENA
309250 - 600x400mm	8.35

Maiņļenkā stūrenis 200mm

STANLEY.



ARTIKULS	CENA
317643 - 200mm	5.900

Alumīnija profils





ARTIKULS	CENA	ARTIKULS	CENA
309330 - 200cm	19.780	309331 - 250cm	23.620

Salokāms metmērs PVC



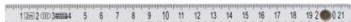

ARTIKULS	CENA
309275 - 2m	2.600

Alumīnija trapecveida profils





ARTIKULS	CENA	ARTIKULS	CENA
309337 - 100cm	10.250	309339 - 200cm	20.990
309338 - 150cm	15.000	309340 - 250cm	23.580

Tērauda lineāls



ARTIKULS	CENA
287311 - 50cm	2.490
287313 - 100cm	5.090

Mērlenta ar magnētu YATO



ARTIKULS	CENA
287075 - 5m×19mm	4.560

**Bīdmērs 0-150mm
(precizitāte: 0.02mm)**



ARTIKULS	CENA
287351 - 150mm	8.400

**Elektroniskais bīdmērs 0-150mm
(precizitāte: 0.01mm)**



ARTIKULS	CENA
287352 - 150mm	19.600

Mērlenta MODECO



ARTIKULS	CENA
309263 - 2m×19mm	1.200
309264 - 3m×19mm	1.500
309265 - 5m×25mm	2.600
309266 - 7.5m×25mm	3.300

Mērlenta KOMELON ECO



ARTIKULS	CENA
306038 - 3m×16mm	3.100
306043 - 5m×19mm	3.960
306044 - 8m×25mm	5.900
306085 - 10m×25mm	10.700

Mērlenta STANLEY



ARTIKULS	CENA
300650 - 3m×12.7mm	4.500
300651 - 5m×19mm	7.700
300652 - 8m×25mm	11.500

Mērlenta MODECO



ARTIKULS	CENA
309256 - 5m×25mm	2.850

**Garā stiklšķiedras mērlente
STANLEY**



ARTIKULS	CENA
300657 - 20m×12.7	13.200

Garā metāla mērlente MODECO



ARTIKULS	CENA
309259 - 30m×13mm	27.000
309260 - 50m×13mm	32.460

Cena norādīta ar PVN

Adīti cimdi ar vienaspusēju punktējumu M51



ARTIKULS CENA
350192 - 0.340

Adīti cimdi ar divpusēju punktējumu M52



ARTIKULS CENA
350194 - 0.430

Gludas kazādas cimdi ar klipsi un elastīgu auduma virspusi 215



ARTIKULS CENA
350175 - 3.200

Īpaši plāni sintētiskās ādas cimdi, elpojoši GUIDE 761



ARTIKULS CENA
351102 - 3.300

Viegli un izturīgi vērsādas darba cimdi GUIDE 30



ARTIKULS CENA
351103 - 4.300

Gludas kazādas cimdi ar klipsi, elastīgu auduma virspusi un silto odiri 252



ARTIKULS CENA
350169 - 3.770

Gludas vērsādas cimdi ar auduma virspusi un silto flaneļa odiri 230



ARTIKULS CENA
351146 - 5.000

Mīksta, elastīga, izturīga vērsādas cimdi 0154



ARTIKULS CENA
350207 - 3.980

Biezas zamšādas cimdi ar stingru manšeti 201A



ARTIKULS CENA
350335 - 2.400

Siltie cūkādas cimdi 206



ARTIKULS CENA
351145 - 2.620

Sintētiskās ādas cimdi ar atstarotāju 300HVS



ARTIKULS CENA
351070 - 2.900

Vērsādas cimdi, šoferu L210-L211



ARTIKULS CENA
350176 - 4.900

Adīti siltie cimdi ar pret slīdes lateksa pārklājumu 1202



ARTIKULS CENA
351150 - 2.600

Neilona trikotāžas cimdi ar lateksa plauksta pārklājumu 124



ARTIKULS CENA
351140 - 1.160

Adīti cimdi ar biezu, sarkanu nitrila plauksta pārklājumu 164



ARTIKULS CENA
350307 - 1.320

Cena norādīta ar PVN

Vienreizējas lietošanas nitrila cimdi 0505



ARTIKULS CENA
350371 - 0.180

Zili PVC naftas produktu izturīgi cimdi 062



ARTIKULS CENA
350350 - 3.900

PVC cimdi ar adītu manšeti un oderi 055



ARTIKULS CENA
350021 - 1.300

Ķivere sarkana



MODECO
ARTIKULS CENA
309508 - 5.800

Celgalu aizsargi gumijas



ARTIKULS CENA
287032 - 5.790

Celgalu aizsargi silikona



ARTIKULS CENA
287030 - 11.790

Ķivere dzeltena



MODECO
ARTIKULS CENA
309509 - 5.800

Respirators ar izelpas vārstu



MODECO
ARTIKULS CENA
288154 - 1.000

Respirators (5 gab.)



MODECO
ARTIKULS CENA
288153 - 3.500

Prettrokšņu austiņas



ARTIKULS CENA
351193 - 7.990

3M FFP1S respirators ar izelpas vārstu



ARTIKULS CENA
350232 - 2.800

3M FFP1S respirators



ARTIKULS CENA
350231 - 1.600

Aizsargbrilles



MODECO
ARTIKULS CENA
309504 - 1.600

Atstarojošā veste dzeltena



ARTIKULS CENA
350374 - 2.900

Atstarojošā veste oranža



ARTIKULS CENA
350375 - 2.900

Cena norādīta ar PVN

Ķerra profesionālā 110l



ARTIKULS CENA
316902 - 46.800

Ķerra cinkota 66l



ARTIKULS CENA
316901 - 27.900

Sniega lāpsta KWAZAR (38×146cm)



ARTIKULS CENA
316990 - 38×146cm 11.300

Lāpsta asgala PRACTICA 117cm



ARTIKULS CENA
314060 - 117cm 18.490

Lāpsta liekšķeru PRACTICA 117cm



ARTIKULS CENA
314061 - 117cm 18.490

Sniega lāpsta (39×47×134cm)



ARTIKULS CENA
316999 - 39×47×134cm 9.880

Lāpsta asgala ar metāla kātu (22×30×125cm)



ARTIKULS CENA
287150 - 22×30×125cm 9.840

Lāpsta liekšķeru ar metāla kātu (24×29×125cm)



ARTIKULS CENA
287149 - 24×29×125cm 9.840

Metāla grābeklis ar koka kātu



ARTIKULS CENA
287220 - 22z×140cm 4.660

Lāpsta asgala ar koka kātu (22.5×29×115cm)



ARTIKULS CENA
287155 - 22.5×29×115cm 5.950

Lāpsta liekšķeru ar koka kātu (24.5×29×115cm)



ARTIKULS CENA
287156 - 24.5×29×115cm 5.950

Metāla grābeklis ar koka kātu



ARTIKULS CENA
287210 - 12z×130cm 3.300
287212 - 16z×140cm 4.130

Slota ITALY



ARTIKULS	CENA
288195 -	7.500

Rokas slotiņa ar koka kātu



ARTIKULS	CENA
285336 -	2.690

Šaufele PVC ar birsti



ARTIKULS	CENA
285339 -	1.990

Birste ar koka kātu (cieti sari)



ARTIKULS	CENA
305695 - 43cm	8.400
305697 - 50cm	12.500

Birste ar koka kātu (mīksti sari)



ARTIKULS	CENA
305691 - 40cm	8.350
305684 - 50cm	8.850

Koka kāts



ARTIKULS	CENA
287170 - 24x1200mm	1.130
287171 - 24x1300mm	1.230
287172 - 24x1400mm	1.460
287173 - 24x1500mm	1.600
287174 - 28x1300mm	1.340
287175 - 28x1400mm	1.500
287176 - 28x1500mm	1.600
287177 - 28x1800mm	2.150
287179 - 38x1000mm	2.120
287180 - 38x1100mm	2.460
287181 - 38x1300mm	2.770

Savilcējsiksniņa balta



ARTIKULS	CENA	ARTIKULS	CENA
200105 - 2.5x100mm	0.010	200120 - 4.8x360mm	0.050
200108 - 3.6x140mm	0.020	200122 - 4.8x430mm	0.070
200110 - 3.6x290mm	0.030	200123 - 7.6x360mm	0.090
200112 - 4.8x160mm	0.030	200124 - 7.6x450mm	0.180
200114 - 4.8x200mm	0.030	200127 - 9.0x780mm	0.270
200117 - 4.8x250mm	0.030	200128 - 9.0x1500mm	0.970
200118 - 4.8x290mm	0.040	200130 - 12.6x1000mm	0.890

Stieple balti cinkota



ARTIKULS	CENA
317000 - 0.6mmx30m	0.800
317001 - 0.9mmx50m	1.200
317002 - 1.5mmx100m	5.090
317003 - 2.5mmx100m	10.000

Savilcējsiksniņa melna



ARTIKULS	CENA	ARTIKULS	CENA
200140 - 2.5x100mm	0.010	200160 - 4.8x360mm	0.050
200142 - 3.6x140mm	0.020	200163 - 4.8x430mm	0.070
200145 - 3.6x290mm	0.030	200165 - 7.6x360mm	0.090
200146 - 4.8x160mm	0.030	200166 - 7.6x450mm	0.180
200150 - 4.8x200mm	0.030	200180 - 9.0x780mm	0.270
200154 - 4.8x250mm	0.030	200181 - 9.0x1500mm	0.970
200156 - 4.8x290mm	0.040	200182 - 12.6x1000mm	0.890

Savilcējsiksniņa zaļa



ARTIKULS	CENA
200190 - 3.6x140mm	0.020
200193 - 4.8x200mm	0.030
200198 - 7.6x250mm	0.090

Mikseris tips A, HEX



ARTIKULS	CENA
288014 - 5-15kg 80x400	3.130
288015 - 15-25kg 100x500	4.060

Mikseris tips C, HEX



ARTIKULS	CENA
288016 - 10-20kg 100x500	4.300
288017 - 16-35kg 120x600	7.550

Plastmasas spainis



ARTIKULS	CENA
306187 - 12l	1.300
306184 - 16l	1.990
306185 - 20l	2.150

Mikseris tips D, HEX



ARTIKULS	CENA
288018 - 10-20kg 80x400	5.300
288019 - 15-30kg 100x500	6.800

Mikseris tips E, HEX



ARTIKULS	CENA
288025 - 5-15kg 80x400	3.500
288026 - 16-25kg 100x500	3.800

Apaļš plastmasas konteiners



ARTIKULS	CENA
319353 - 40l	4.550
319351 - 65l	5.500
319352 - 90l	7.450

Mikseris tips C, SDS+



ARTIKULS	CENA
288024 - 16-35kg 120x600	12.500

Mikseris tips F, M14



ARTIKULS	CENA
288027 - 10-30kg 120x600	15.000

Plastmasas spainis



ARTIKULS	CENA
287000 - 8l	1.900

LDPE atkritumu maisi (melni)



ARTIKULS	CENA	ARTIKULS	CENA
280753 - 75l (10gab.)	1.320	280756 - 200l (10gab.)	2.380
280754 - 100l (10gab.)	1.440	280757 - 250l (5gab.)	1.730
280755 - 150l (10gab.)	2.100	280758 - 300l (5gab.)	2.180

Taisnstūra plastmasas konteiners



ARTIKULS	CENA
319340 - 40l	4.950
319341 - 60l	5.700
319342 - 90l	6.970

LDPE atkritumu maisi īpaši izturīgie (tumši zaļi)



ARTIKULS	CENA	ARTIKULS	CENA
280760 - 100l (5gab.)	1.900	280762 - 200l (5gab.)	2.380
280761 - 150l (5gab.)	1.990	280763 - 250l (5gab.)	3.000

Polipropilēna maisi (balti)



ARTIKULS	CENA
314000 -	0.320

Špaktelļāpsta nerūsējošā, plastmasas rokturis



ARTIKULS	CENA
285816 - 150mm	0.660
285817 - 200mm	0.870
285818 - 250mm	1.120
285820 - 350mm	1.520
285822 - 450mm	1.980
285824 - 600mm	2.940

Špaktelļāpsta nerūsējošā ar zobiem, plastmasas rokturis



ARTIKULS	CENA
285823 - 150mm 6x6z	0.680
285825 - 150mm 8x8z	0.680
285826 - 200mm 6x6z	0.880
285827 - 200mm 8x8z	0.880
282828 - 250mm 6x6z	1.140
285829 - 250mm 8x8z	1.140

Rīvdēlis nerūsējošā tērauda ar zobiem, koka rokturis



ARTIKULS	CENA
285790 - 130x380 6x6z	5.800
285791 - 130x380 8x8z	5.800
285792 - 130x380 10x10z	5.800
285793 - 130x480 6x6z	7.020
285794 - 130x480 8x8z	7.020
285795 - 130x480 10x10z	7.020

Špaktelļāpsta nerūsējošā ar alumīnija stiprinājumu, divkomponentu rokturi



ARTIKULS	CENA
285010 - 17cm	5.600
285011 - 22cm	6.730

Špaktelļāpsta nerūsējošā ar alumīnija stiprinājumu, divkomponentu rokturi



ARTIKULS	CENA
285013 - 30cm	7.400
285014 - 50cm	10.400

Rīvdēlis nerūsējošā tērauda, koka rokturis



ARTIKULS	CENA
285772 - 130x480mm	6.660

Ķelle trīstūrveida 18cm



ARTIKULS	CENA
285000 - 18cm	5.700

Ķelle noapaļota 18x11cm



ARTIKULS	CENA
285001 - 18x11cm	4.800

Rīvdēlis nerūsējošais ar zobiem, plastmasas rokturis



ARTIKULS	CENA
285779 - 130x270 8x8z	2.440
285780 - 130x270 10x10z	2.440

Ķelle trapecveida 16x11cm



ARTIKULS	CENA
285002 - 16x11cm	4.670

Ķelle taisna 10x12cm



ARTIKULS	CENA
285005 - 10x12cm	3.800

Rīvdēlis nerūsējošais, plastmasas rokturis



ARTIKULS	CENA
285776 - 130x270mm	2.440

Ķelle ārējiem stūriem



ARTIKULS	CENA
286920 - 80x60mm	2.300

Ķelle iekšējiem stūriem



ARTIKULS	CENA
286921 - 80x60mm	2.300

Švotājs



ARTIKULS	CENA
308790 - 8mm	1.900

Gumijas špaktelļāpsta



ARTIKULS	CENA
285800 - 150mm	0.630
285801 - 200mm	0.820
285802 - 250mm	0.940
285803 - 300mm	1.200

Špaktelļāpsta nerūsejoša, gumijas rokturis



ARTIKULS	CENA
285783 - 50mm	1.200
285784 - 60mm	1.350
285785 - 80mm	1.500
285786 - 100mm	1.600

Poliuretāna rīvdēlis



ARTIKULS	CENA
311747 - 140x260mm	2.750
311748 - 140x280mm	3.100
311749 - 180x320mm	4.660
311750 - 220x420mm	7.120
311757 - 240x480mm	8.900
311751 - 120x1200mm	14.700

Apmetēja kauss



ARTIKULS	CENA
288188 - 175mm	1.700

Špaktelļāpsta trīstūris



ARTIKULS	CENA
308860 - 50x50x50mm	3.000

Poliuretāna sūklis



ARTIKULS	CENA
287270 - 165x100x60mm	0.700

Pistole hermētiķiem 310ml



ARTIKULS	CENA
309780 - 310ml	3.100

Pistole hermētiķiem 310ml

MODECO



ARTIKULS	CENA
309781 - 310ml	6.760

Poliuretāna sūklis



ARTIKULS	CENA
287271 - 165x100x80mm	1.550

Pistole hermētiķiem MK5 600ml

Den Braven



ARTIKULS	CENA
282897 - 600ml	46.000

Pistole hermētiķiem 600ml



ARTIKULS	CENA
286944 - 600ml	8.840

Porainais sūklis



ARTIKULS	CENA
287272 - 150x100x50mm	0.820

Pistole putām GUN 355

Den Braven



ARTIKULS	CENA
282899 -	13.200

Pistole putām GUN 635

Den Braven



ARTIKULS	CENA
282900 -	20.700

Pistole putām S1

PENOSIL



ARTIKULS	CENA
282889 -	16.900

BŪVĶĪMIJA

Antiseptiķi, šķīdinātāji 83

Cena norādīta ar PVN

Koka antiseptiķis RP WOOD, bezkrāsains



ARTIKULS	CENA
315665 - 5l	5.300
315670 - 10l	10.680

Koka antiseptiķis RP WOOD, brūns



ARTIKULS	CENA
315666 - 5l	5.300
315671 - 10l	10.680

Koka antiseptiķis RP WOOD, zaļš



ARTIKULS	CENA
315667 - 5l	5.300
315672 - 10l	10.680

Antiseptiķis-koncentrāts BOCHEMIT OPTIMAL+, brūns 1:16



ARTIKULS	CENA
315611 - 5l	55.500

Antiseptiķis-koncentrāts BOCHEMIT OPTIMAL+, zaļš 1:16



ARTIKULS	CENA
315612 - 5l	55.500

Antiseptiķis-koncentrāts BOCHEMIT QB HOBBY, zaļš 1:2



ARTIKULS	CENA
315603 - 1kg	3.980

Uguns aizsardz. antiseptiķis-koncentrāts BOCHEMIT ANTIFLASH, brūns 1:9



ARTIKULS	CENA
315628 - 5l	43.900

Uguns aizsardz. antiseptiķis-koncentrāts BOCHEMIT ANTIFLASH, zaļš 1:9



ARTIKULS	CENA
315629 - 5l	43.900

Antiseptiķis-koncentrāts BOCHEMIT QB HOBBY, brūns 1:2



ARTIKULS	CENA
315604 - 1kg	3.980

Acetons



ARTIKULS	CENA
400521 - 0.5l	1.320
400522 - 1l	2.300
400523 - 5l	9.900

Vaļspirts RS-2



ARTIKULS	CENA
400529 - 0.5l	1.390
400530 - 1l	2.350
400531 - 5l	11.330

Petroleja



ARTIKULS	CENA
400540 - 0.5l	1.470
400541 - 1l	2.660
400542 - 5l	12.160

Šķīdinātājs 646



ARTIKULS	CENA
400506 - 0.5l	1.540
400507 - 1l	2.350
400509 - 5l	10.600

Šķīdinātājs 647



ARTIKULS	CENA
400510 - 0.5l	1.650
400511 - 1l	3.460
400513 - 5l	13.500

Šķīdinātājs 650



ARTIKULS	CENA
400515 - 0.5l	1.820
400516 - 1l	3.480
400518 - 5l	13.740

RITEŅI

TENTE riteņi	85
Riteņi	86

Grozāms ritenis 3470PVO



ARTIKULS CENA
304212 - D80mm (70kg) 5.150

Fiksēts ritenis 3478PVO



ARTIKULS CENA
304213 - D80mm (70kg) 4.300

Grozāms ritenis + bremze 3477PVO



ARTIKULS CENA
304214 - D80mm (70kg) 7.100

Grozāms ritenis 3470DVR



ARTIKULS CENA
304195 - D100mm (70kg) 6.900
304192 - D125mm (100kg) 7.900
304189 - D160mm (135kg) 14.900
304186 - D200mm (205kg) 15.940

Fiksēts ritenis 3478DVR



ARTIKULS CENA
304196 - D100mm (70kg) 6.120
304193 - D125mm (100kg) 6.960
304190 - D160mm (135kg) 10.460
304187 - D200mm (205kg) 11.900

Grozāms ritenis + bremze 3477DVR



ARTIKULS CENA
304197 - D100mm (70kg) 9.950
304194 - D125mm (100kg) 11.800
304191 - D160mm (135kg) 18.900
304188 - D200mm (205kg) 20.900

Grozāms ritenis 3470UOO



ARTIKULS CENA
304171 - D80mm (200kg) 4.800

Fiksēts ritenis 3478UOO



ARTIKULS CENA
304172 - D80mm (200kg) 3.560

Grozāms ritenis + bremze 3477UOO



ARTIKULS CENA
304173 - D80mm (200kg) 6.900

Grozāms ritenis 3470UOR



ARTIKULS CENA
304174 - D100mm (200kg) 7.300
304177 - D125mm (250kg) 8.900
304180 - D160mm (350kg) 14.870
304183 - D200mm (350kg) 22.200

Fiksēts ritenis 3478UOR



ARTIKULS CENA
304175 - D100mm (200kg) 5.900
304178 - D125mm (250kg) 6.400
304182 - D160mm (350kg) 13.310
304184 - D200mm (350kg) 18.200

Grozāms ritenis + bremze 3477UOR



ARTIKULS CENA
304176 - D100mm (200kg) 10.400
304179 - D125mm (250kg) 12.750
304181 - D160mm (350kg) 18.360
304185 - D200mm (350kg) 27.900

Grozāms ritenis



ARTIKULS	CENA
222362 - D50mm (30kg)	1.400

Fiksēts ritenis



ARTIKULS	CENA
300348 - D50mm (30kg)	1.200

Grozāms ritenis + bremze



ARTIKULS	CENA
222363 - D50mm (30kg)	1.950

Grozāms ritenis



ARTIKULS	CENA
240048 - D50mm (50kg)	1.250
240040 - D75mm (70kg)	2.600
240058 - D100mm (80kg)	4.200

Fiksēts ritenis



ARTIKULS	CENA
240050 - D50mm (50kg)	0.850
240041 - D75mm (70kg)	2.050
240057 - D100mm (80kg)	3.300

Grozāms ritenis + bremze



ARTIKULS	CENA
240049 - D50mm (50kg)	1.600
240042 - D75mm (70kg)	3.700
240059 - D100mm (80kg)	5.500

Grozāms ritenis ar urbumu



ARTIKULS	CENA
240051 - D50mm (50kg)	1.200
240045 - D75mm (70kg)	2.300
240060 - D100mm (80kg)	4.200

Grozāms ritenis ar urbumu + bremze



ARTIKULS	CENA
240052 - D50mm (50kg)	1.420
240046 - D75mm (70kg)	3.500
240061 - D100mm (80kg)	5.200

Grozāms ritenis ar skrūvi M8x25



ARTIKULS	CENA
300382 - D50mm (40kg)	2.700

Grozāms dubulritenis



ARTIKULS	CENA
300388 - D50mm (70kg)	3.800

Grozāms dubulritenis + bremze



ARTIKULS	CENA
300389 - D50mm (70kg)	4.200

Grozāms ritenis ar skrūvi M8x25 + bremze



ARTIKULS	CENA
300383 - D50mm (40kg)	3.500

Grozāms dubulritenis ar urbumu D10mm



ARTIKULS	CENA
300386 - D50mm (70kg)	3.800

Grozāms dubulritenis ar urbumu D10mm + bremze



ARTIKULS	CENA
300387 - D50mm (70kg)	4.280

Ritenis PRU



ARTIKULS	CENA
304088 - D250mm	7.200

