

Product Information



3477UOR160P63

EAN 4031582306187

Swivel castor with total lock, tail end of castor, housing made of pressed steel, bright zinc plated, blue passivated, double ball bearing swivel head, wheel axle with nut, dustguard, plate fitting. Wheel centre made of Polyamide, roller bearing



Technical Data	
Wheel diameter	160 mm
Width of Tread	40 mm
Size of Plate	137 x 105 mm
Plate hole centres	105 x 80/75 mm
Plate hole	11 mm
Offset	60 mm
Swivel Interference	334 mm
Overall height	200 mm
Temperature	- 40 / + 80 °C
Standard	EN 12532
Weight	2.16 kg
Swivel Radius	167 mm
Hardness of tread	Shore D 75
Load capacity	350 kg
Load capacity (static)	700 kg

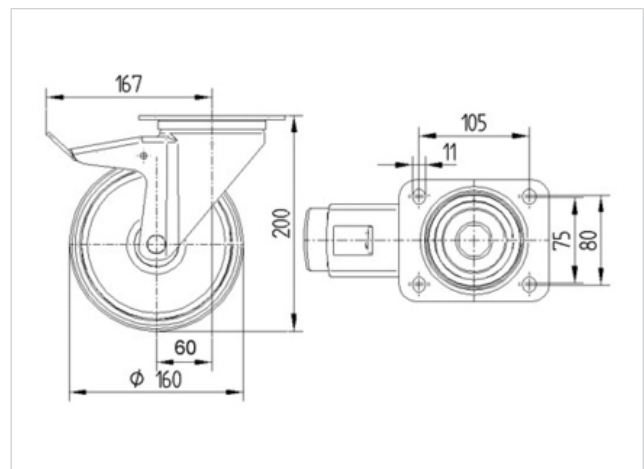

Roll performance	+	+	+	+	+
Movement noise	+	+	+	+	+
Attrition	+	+	+	+	+
Corrosion resistance	+	+	+	+	+

Product Information



3477UOR160P63

EAN 4031582306187

