

Product Information



3477DVR100P62

EAN 4031582050226

Swivel castor with total lock, tail end of castor, housing made of pressed steel, bright zinc plated, blue passivated, double ball bearing swivel head, wheel axle with nut, dustguard, plate fitting. Wheel centre made of pressed steel, Tread: solid rubber, black, roller bearing

Technical Data

Wheel diameter	100 mm
Width of Tread	30 mm
Size of Plate	105 x 85 mm
Plate hole centres	80/77 x 60 mm
Plate hole	9 mm
Offset	41 mm
Swivel Interference	246 mm
Overall height	128 mm
Temperature	- 20 / + 60 °C
Standard	EN 12532
Weight	1.122 kg
Swivel Radius	123 mm
Hardness of tread	Shore A 85
Load capacity	70 kg
Load capacity (static)	140 kg

Roll performance	+	+	+	+	+
Movement noise	+	+	+	+	+
Attrition	+	+	+	+	+
Corrosion resistance	+	+	+	+	+

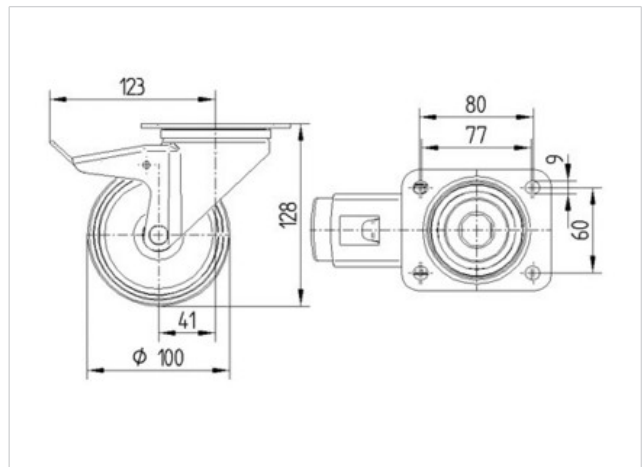



3477DVR100P62

EAN 4031582050226

