

**INSTYTUT TECHNIKI BUDOWLANEJ**  
**PL 00-611 WARSZAWA**  
ul. FILTROWA 1  
tel.: (48 22) 825-04-71;  
(48 22) 825-76-55;  
fax: (48 22) 825-52-86;  
www.itb.pl



**Członek EOTA**

## European Technical Approval

**ETA-12/0394**

(English language translation – the original version is in Polish language)

<b>Nazwa handlowa</b> <i>Trade name</i>	<b>RAWL R-KEM II / RAWL R-KEM II-S / RAWL R-KEM II-W i RAWL RM50 / RAWL RM50-S / RAWL RM50-W</b> <i>RAWL R-KEM II / RAWL R-KEM II-S / RAWL R-KEM II-W and RAWL RM50 / RAWL RM50-S / RAWL RM50-W</i>
<b>Właściciel aprobaty</b> <i>Holder of approval</i>	<b>RAWLPLUG S.A.</b> <b>ul. Kwidzyńska 6</b> <b>51-416 Wrocław</b> <b>Poland</b>
<b>Rodzaj i przeznaczenie wyrobu</b> <i>Generic type and use of construction products</i>	<b>Kotwy wklejane z prętami ze stali ocynkowanej lub stali odpornej na korozję o średnicach M8 do M30 do wykonywania zamocowań w betonie niezarysowanym</b> <i>Bonded anchor with anchor rod made of galvanized steel or stainless steel of sizes M8 to M30 for use in non-cracked concrete</i>
<b>Termin ważności</b> <i>Valid</i>	<b>od</b> <i>from</i> <b>do</b> <i>to</i>
<b>Zakład produkcyjny</b> <i>Manufacturing plant</i>	<b>Zakład Produkcyjny nr 3</b> <i>Manufacturing Plant no. 3</i>
<b>Niniejsza Europejska Aprobata Techniczna zawiera</b> <i>This European Technical Approval contains</i>	<b>20 stron, w tym 11 Załączników</b> <i>20 pages including 11 Annexes</i>
<b>Niniejsza Europejska Aprobata Techniczna zastępuje</b> <i>This European Technical Approval replaces</i>	<b>ETA-12/0394 ważną od 10.12.2012 do 10.12.2017</b> <i>ETA-12/0394 with validity from 10.12.2012 to 10.12.2017</i>



Europejska Organizacja ds. Aprobatach Technicznych

European Organisation for Technical Approvals

## I LEGAL BASES AND GENERAL CONDITIONS

1. This European Technical Approval is issued by Instytut Techniki Budowlanej in accordance with:
  - Council Directive 89/106/EEC of 21 December 1988 on the approximation of laws, regulations and administrative provisions of Member States relating to construction products<sup>1</sup>, amended by the Council Directive 93/68/EEC of 22 July 1993<sup>2</sup>;
  - ustawa z dnia 16 kwietnia 2004 r. o wyrobach budowlanych (law on construction products from 16<sup>th</sup> April 2004)<sup>3</sup>;
  - rozporządzenie Ministra Infrastruktury z dnia 14 października 2004 r. w sprawie europejskich aprobat technicznych oraz polskich jednostek organizacyjnych upoważnionych do ich wydawania (regulation of the Ministry of Infrastructure of 14<sup>th</sup> October 2004 on the European Technical Approvals and Polish bodies entitled to issue them)<sup>4</sup>;
  - Common Procedural Rules for Requesting, Preparing and the Granting of European Technical Approvals set out in the Annex of Commission Decision 94/23/EC<sup>5</sup>;
  - Guideline for European Technical Approval of “*Metal anchors for use in concrete – Part 5: Bonded anchors*”, ETAG 001-05;
2. Instytut Techniki Budowlanej is authorized to check whether the provisions of this European Technical Approval are met. Checking may take place in the manufacturing plant. Nevertheless, the responsibility for the conformity of the products to the European Technical Approval and for their fitness for the intended use remains with the holder of the European Technical Approval.
3. This European Technical Approval is not to be transferred to manufacturers or agents of manufacturers other than those indicated on page 1, or manufacturing plants other than those indicated on page 1 of this European Technical Approval.
4. This European Technical Approval may be withdrawn by Instytut Techniki Budowlanej, in particular after information by the Commission on the basis of Article 5(1) of Council Directive 89/106/EEC.
5. Reproduction of this European Technical Approval including transmission by electronic means shall be in full. However, partial reproduction can be made with the written consent of Instytut Techniki Budowlanej. In this case partial reproduction has to be designated as such. Texts and drawings of advertising brochures shall not contradict or misuse the European Technical Approval.
6. The European Technical Approval is issued by the approval body in its official language. This version corresponds to the version circulated within EOTA. Translations into other languages have to be designated as such.

---

<sup>1</sup> Official Journal of the European Communities № L 40, 11.02.1989, p. 12

<sup>2</sup> Official Journal of the European Communities № L 220, 30.08.1993, p. 1

<sup>3</sup> Official Journal of Polish Republic № 92/2004, pos. 881

<sup>4</sup> Official Journal of Polish Republic № 237/2004, pos. 2375

<sup>5</sup> Official Journal of the European Communities № L 17, 20.01.1994, p. 34

## **II SPECIFIC CONDITIONS OF THE EUROPEAN TECHNICAL APPROVAL**

### **1 Definition of product and intended use**

#### **1.1 Definition of product**

The subject of this approval are the bonded anchors (injection type) consisting of the injection mortar RAWL R-KEM II / RAWL R-KEM II-S / RAWL R-KEM II-W and RAWL RM50 / RAWL RM50-S / RAWL RM50-W cartridge using an applicator gun equipped with a special mixing nozzle and threaded anchor rod of the sizes M8 to M30. Anchor rods are made of galvanized carbon steel or stainless steel A4-70 or A4-80: 1.4401, 1.4404, 1.4571 or high corrosion resistant stainless steel in strength class 70: 1.4529, 1.4565, 1.4547 with hexagon nut and washer.

The threaded rod is placed into a drilled hole previously cleaned and injected with a mortar with a slow and slight twisting motion. The threaded rod is anchored by the bond between rod, mortar and concrete.

The threaded rods are available for all diameters with three type of tip end: a one side 45° chamfer, a two sides 45° chamfer or a flat. The threaded rods are either delivered with the mortar cartridges or commercial standard threaded rods purchased separately. The mortar cartridges are available in different sizes: 150 ml to 825 ml and types: two part foil capsules in one cartridge, coaxial cartridge, side by side cartridge or foil capsules. The anchors are intended to be used with embedment depth given in Annex 6, Table 3.

For the installed anchor see Figure given in Annex 1.

#### **1.2 Intended use**

The anchors are intended to be used for anchorages for which requirements for mechanical resistance and stability and safety in use in the sense of the Essential Requirements 1 and 4 of Council Directive 89/106/EEC shall be fulfilled and failure of anchorages made with these products would compromise the stability of the works, cause risk to human life and/or lead to considerable economic consequences. Safety in the case of fire (Essential Requirement 2) is not covered by this ETA. The anchors are to be used only for anchorages subject to static or quasi-static loading in reinforced or unreinforced normal weight concrete of strength class C20/25 at minimum to C50/60 at maximum according to EN 206-1.

The anchors may be anchored in non-cracked concrete only.

The anchors may be installed in dry or wet concrete (use category 1) or in flooded holes with the exception of seawater (use category 2).

The anchors may be used in the following temperature range:

- a) -40°C to +40°C (max. short term temperature +40°C and max. long term temperature +24°C),
- b) -40°C to +80°C (max. short term temperature +80°C and max. long term temperature +50°C).

Elements made of zinc coated steel may be used in structures subject to dry internal conditions only.

Elements made of stainless steel may be used in structures subject to dry internal conditions and also in concrete subject to external atmospheric exposure (including industrial and marine environment) or exposure in permanently damp internal conditions if no particular aggressive conditions exist. Such particular aggressive conditions are e.g. permanent, alternating immersion in seawater or the splash zone of seawater, chloride atmosphere of indoor swimming pools or atmosphere with extreme chemical pollution (e.g. in desulphurization plants or road tunnels where de-icing materials are used).

Elements made of high corrosion resistant steel may be used in structures subject to dry internal conditions and also in concrete subject to external atmospheric exposure or exposure in permanently damp internal conditions or in other particular aggressive conditions. Such particular aggressive conditions are e.g. permanent, alternating immersion in seawater or the splash zone of seawater, chloride atmosphere of indoor swimming pools or atmosphere with chemical pollution (e.g. in desulphurization plants or road tunnels where de-icing materials are used).

The provisions made in this European Technical Approval are based on an assumed intended working life of the anchor of 50 years. The indications given on the working life cannot be interpreted as a guarantee given by the producer or Approval Body, but are to be regarded only as a means for choosing the right products in relation to the expected economically reasonable working life of the works.

## **2 Characteristics of product and methods of verification**

### **2.1 Characteristics of product**

The anchors of the sizes of M8 to M30 and the mortar cartridges correspond to the drawings and provisions given in Annexes 1 to 3. The characteristic material values, dimensions and tolerances of the anchors not indicated in Annexes shall correspond to the respective values laid down in the technical documentation<sup>6</sup> of this European Technical Approval.

The characteristic anchor values for the design of anchorages are given in Annexes 8 to 11.

Each mortar cartridge is marked with the identifying mark of the producer and with the trade name. The threaded rods are either delivered with the mortar cartridges or commercial standard threaded rods are purchased separately.

The two components of the injection mortar are delivered in unmixed condition in mortar cartridges in a size of 150 to 600 ml in the case of two part foil capsules in the cartridge, 345 to 825 ml in the case of side by side cartridge, 150 to 410 ml in the case of coaxial cartridge and 150 to 600 ml in the case of foil capsule, in accordance with Annexes 2 and 3.

The injection mortar delivered in two part foil capsules in the cartridge, side by side cartridges or coaxial cartridge bears the trade names RAWL R-KEM II, RAWL R-KEM II-S or RAWL R-KEM II-W. The injection mortar delivered in foil capsule bears the trade names RAWL RM50, RAWL RM50-S or RAWL RM50-W.

---

<sup>6</sup> The technical documentation of this European Technical Approval is deposited at Instytut Techniki Budowlanej and, as far as relevant for the tasks of the approved body involved in the attestation of conformity procedure, may be handed over only to the approved body involved.

## **2.2 Methods of verification**

The assessment of fitness of the anchors for the intended use in relation to the requirements for mechanical resistance and stability and safety in use in the sense of the Essential Requirements 1 and 4 has been made in accordance with the ETAG 001 Guideline for European Technical Approval of *"Metal anchors for use in concrete"*, Part 1: *"Anchors in general"* and Part 5: *"Bonded anchors"*, on the basis of Option 7.

In addition to the specific clauses relating to dangerous substances contained in this European Technical Approval, there may be other requirements applicable to the products falling within its scope (e.g. transposed European legislation and national laws, regulations and administrative provisions). In order to meet the provisions of the Construction Products Directive, these requirements need also to be complied with, when and where they apply.

## **3 Evaluation of Conformity and CE marking**

### **3.1 System of attestation of conformity**

The system of attestation of conformity 2 (i) (referred to as system 1) according to Council Directive 89/106/EEC Annex III laid down by the European Commission provides:

(a) Tasks of the manufacturer:

- 1) factory production control,
- 2) further testing of samples taken at the factory by the manufacturer in accordance with a prescribed test plan;

(b) Tasks of the approved body:

- 3) initial type-testing of the product,
- 4) initial inspection of factory and of factory production control,
- 5) continuous surveillance, assessment and approval of factory production control.

### **3.2 Responsibilities**

#### **3.2.1 Tasks of the manufacturer; factory production control**

The manufacturer has a factory production control system in the plant and shall exercise permanent internal control of production. All the elements, requirements and provisions adopted by the manufacturer are documented in a systematic manner in the form of written policies and procedures. This production control system ensures that the product is in conformity with the European Technical Approval.

The manufacturer shall only use raw materials supplied with the relevant inspection documents as laid down in the control plan<sup>7</sup>. The incoming raw materials shall be subject to controls and tests by the manufacturer before acceptance. Check of incoming materials such as nuts, washers, threaded rods, resin, hardeners shall include control of the inspection documents presented by suppliers (comparison with nominal values) by verifying dimensions and determining material properties.

---

<sup>7</sup> The control plan has been deposited at Instytut Techniki Budowlanej and may be handed over only to the approved body involved in the attestation of conformity procedure.

The frequency of controls and tests conducted during production is laid down in the control plan taking account of the automated manufacturing process of the anchors.

The results of factory production control are recorded and evaluated. The records include at least the following information:

- designation of the product, basic materials and components,
- type of control or testing,
- date of manufacture of the product and date of testing of the product or basic material or components,
- result of control and testing and, if appropriate, comparison with requirements,
- signature of person responsible for factory production control.

The records shall be presented to the approved body involved in continuous surveillance. On request, they shall be presented to Instytut Techniki Budowlanej.

Details of the extent, nature and frequency of testing and controls to be performed within the factory production control shall correspond to the control plan which is part of the technical documentation of this European Technical Approval.

### **3.2.2 Tasks of the approved body**

#### **3.2.2.1 Initial type-testing of the product**

For initial type-testing the results of the tests performed as part of the assessment for the European Technical Approval shall be used unless there are changes in the production line or plant. In such cases the necessary initial type-testing has to be agreed between the Instytut Techniki Budowlanej and the approved body involved.

#### **3.2.2.2 Initial inspection of factory and of factory production control**

The approved body shall ascertain that, in accordance with the control plan, the factory, in particular the staff and equipment, and the factory production control are suitable to ensure continuous and orderly manufacturing of the anchor according to the specifications mentioned in clause 2.1 as well as to the Annexes to this European Technical Approval.

#### **3.2.2.3 Continuous surveillance**

Continuous surveillance and assessment of factory production control have to be performed according to the control plan.

The approved body shall visit the factory at least once a year for surveillance. It has to be verified that the system of factory production control and the specified automated manufacturing process are maintained taking account of the control plan.

The results of continuous surveillance shall be made available on demand by the approved body to Instytut Techniki Budowlanej. In cases where the provisions of the European Technical Approval and the control plan are no longer fulfilled the conformity certificate shall be withdrawn.

### **3.3 CE-marking**

The CE marking shall be affixed on each packaging of the anchors. The letters "CE" shall be accompanied by the following information:

- identification number of the approved body,
- name and address of the holder of the approval,
- last two digits of the year in which the CE marking was affixed,

- number of the EC certificate of conformity,
- number of the European Technical Approval,
- number of the guideline for the European Technical Approval,
- use category (ETAG 001-01, Option 7),
- size.

## **4 Assumptions under which the fitness of the product for the intended use was favourably assessed**

### **4.1 Manufacturing**

The anchors are manufactured in accordance with the provisions of the European Technical Approval using the automated manufacturing process as identified during inspection of the plant by Instytut Techniki Budowlanej and laid down in the technical documentation.

### **4.2 Installation**

#### **4.2.1 Design of anchorages**

The fitness of the anchors for the intended use is given under the following conditions:

- the anchorages are designed in accordance with EOTA Technical Report 029 “*Design of bonded anchors*” (TR 029) under the responsibility of an engineer experienced in anchorages,
- verifiable calculation notes and drawings are prepared taking account of the loads to be anchored,
- the position of the anchor is indicated on the design drawings (e.g. position of the anchor relative to reinforcement or to support, etc.).

#### **4.2.2 Installation of the anchors**

The fitness for use of the anchors can only be assumed if the anchors are installed as follows:

- anchors installation carried out by appropriately qualified personnel and under the supervision of the person responsible for technical matters on the site,
- use of the anchor only as supplied by the manufacturer without exchanging the components of an anchor,
- use of the anchor with commercial standard threaded rods (in the case of rods made of galvanized steel – standard rods of the strength class  $\leq 8.8$  only), washers and hexagonal nuts under the following requirements:
  - material, dimensions and mechanical properties according to the specifications given in Annexes 5 to 6,
  - confirmation of material and mechanical properties by inspection certificate 3.1 according to EN-10204:2004; the documents should be stored,
  - marking of the threaded rod with the envisaged embedment depth; this may be done by the manufacturer of the rod or the person on a job site,

- anchors installation in accordance with the Annex 7, manufacturer's specifications and drawings using the tools indicated in the technical documentation of this European Technical Approval,
- checks before placing the anchor to ensure that the strength class of the concrete in which the anchor is to be placed is in the range given and is not lower than that of the concrete to which the characteristics loads apply,
- check of concrete being well compacted, e.g. without significant voids,
- keeping the effective anchorage depth,
- keeping of the edge distance and spacing to the specified values without minus tolerances,
- positioning of the drill holes without damaging the reinforcement,
- in case of aborted drill hole: the drill hole shall be filled with mortar,
- clearing the hole of drilling dust: the hole shall be cleaned by at least four blowing operations, by at least four brushing operations followed again by at least four blowing operations, before brushing checking whether the brush diameter according to Annex 4 is sufficient,
- anchor installation ensuring the specified embedment depth, that is the appropriate depth marking of the anchor not exceeding the concrete surface or embedment depth control,
- mortar injection by using the equipment including the special mixing nozzle (mixer) shown in Annexes 2 and 3; discarding the first swings of mortar of each new cartridge until an homogeneous color is achieved; taking from the manufacturer instruction the admissible processing time (open time) as a function of the ambient temperature of the concrete; filling the drill hole uniformly from the drill hole bottom, in order to avoid entrapment of air; removing the special mixing nozzle slowly bit by bit during pressing-out; filling the drill hole with a quantity of the injection mortar corresponding to 2/3 of the drill hole depth; inserting immediately the threaded rod, slowly and with a slight twisting motion, removing excess of injection mortar around the rod; observing the loading (curing) time according to Annex 4, Table 3 until the rod may be loaded,
- anchor component installation temperature shall be at least +5°C,
- during installation and curing of the injection mortar the temperature of the concrete must not fall below the temperature given in Annex 5, Table 2,
- application of the torque moment given in Annex 6, Table 3 using a calibrated torque wrench.

#### **4.2.3 Responsibility of the manufacturer**

It is the manufacturer's responsibility to ensure that the information on the specific conditions according to (1) and (2) including Annexes referred to in 4.2.1 and 4.2.2 is given to those who are concerned. This information may be made by reproduction of the respective parts of the European Technical Approval. In addition all installation data shall be shown clearly on the package and/or on an enclosed instruction sheet, preferably using illustration(s).

The minimum data required are:

- drill bit diameter,
- threaded rod diameter,
- minimum installation depth,



- maximum thickness of the fixture,
- required torque moment,
- admissible service temperature range,
- loading (curing) time of the bonding material depending on the installation temperature,
- information on the installation procedure, including cleaning of the hole, preferably by means of the illustrations,
- reference to any special installation equipment needed,
- identification of the manufacturing batch.

All the data shall be presented in a clear and explicit form.

## **5 Recommendations on packaging, transport and storage**

The mortar cartridges shall be protected against sun radiation and shall be stored according to the manufacturer's instructions in dry conditions at temperatures of at least +5°C to not more than +25°C.

Mortar cartridges with expired shelf life must no longer be used.

On behalf of Instytut Techniki Budowlanej



Jan Bobrowicz  
Director of ITB

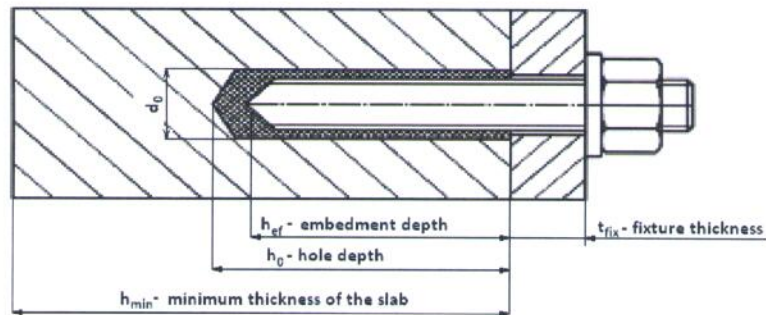
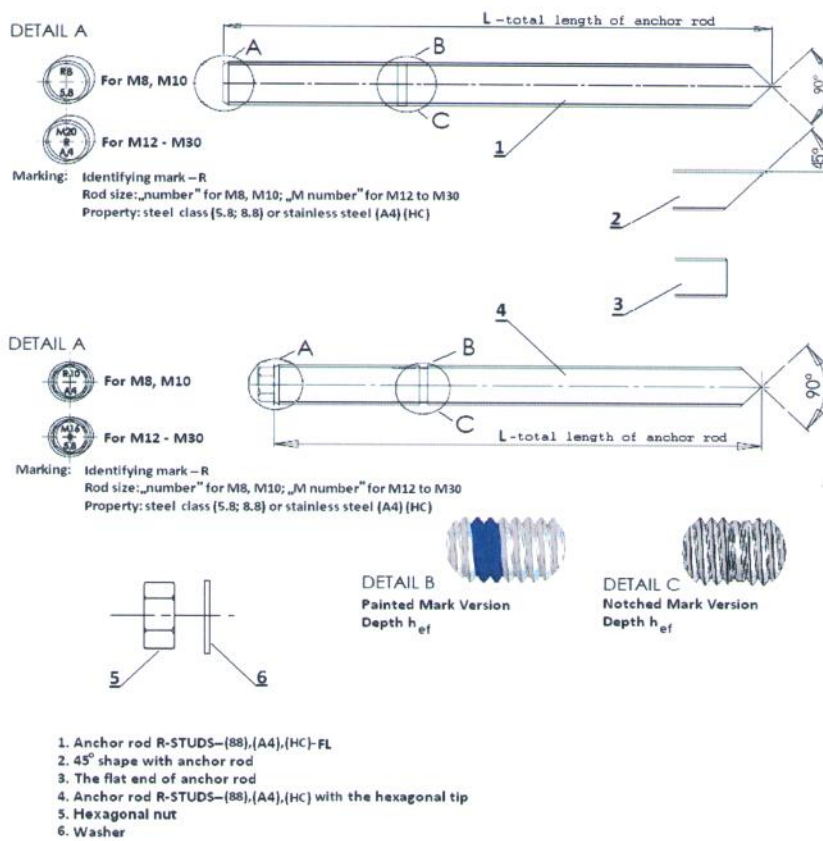

Use in non-cracked concrete only.

**Use category 1 and 2:** installation in dry or wet concrete or in a flooded holes (not sea water)

**Temperature range:**  
 -40°C to +40°C (max. short term temperature +40°C and max. long term temperature +24°C)  
 -40°C to +80°C (max. short term temperature +80°C and max. long term temperature +50°C)

**RAWL R-KEM II / RAWL R-KEM II-S / RAWL R-KEM II-W  
 and RAWL RM50 / RAWL RM50-S / RAWL RM50-W**

Product and intended use

**Annex 1**  
 of European  
 Technical Approval  
 ETA-12/0394

**Coaxial cartridge –**

**150 ml, 280 ml, 300 ml, 310 ml, 330 ml, 380 ml, 400 ml, 410 ml, 420 ml.**

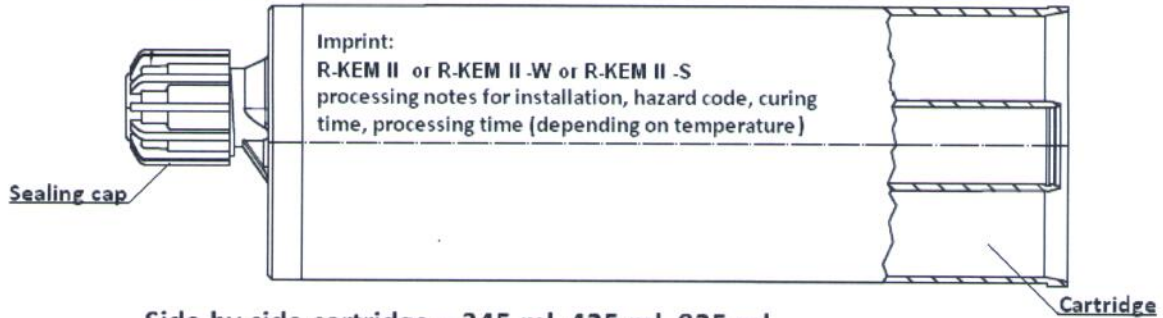

**Side by side cartridge – 345 ml, 425 ml, 825 ml.**

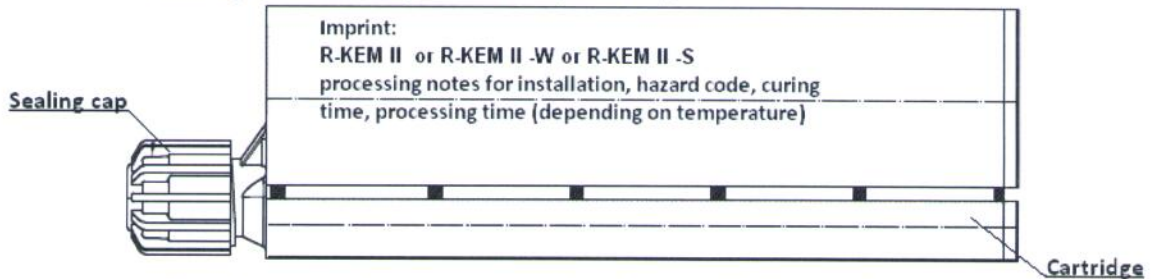

**Cartridge a single component for two part foil capsules –**

**150 ml, 175 ml, 280ml, 300 ml, 310 ml, 380 ml, 400 ml, 550 ml, 600 ml.**

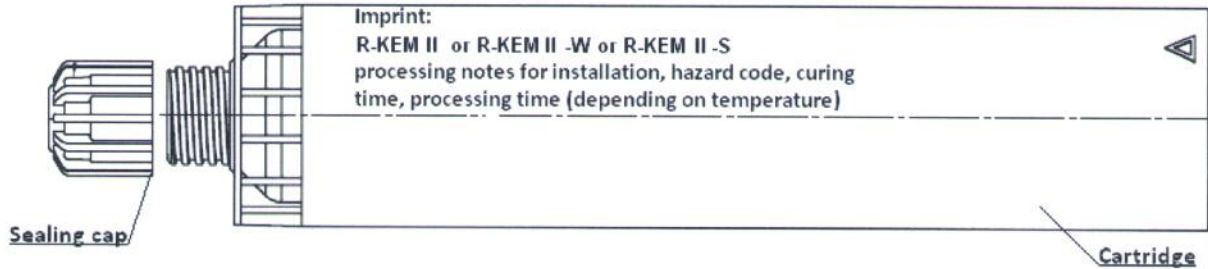

**Mixer for cartridge**

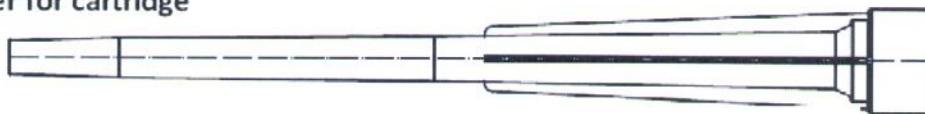

**RAWL R-KEM II / RAWL R-KEM II-S / RAWL R-KEM II-W  
 and RAWL RM50 / RAWL RM50-S / RAWL RM50-W**

Cartridge types and sizes (1)

**Annex 2**  
 of European  
 Technical Approval  
 ETA-12/0394

**Foil capsule (RAWL CFS system) –**

**150 ml, 175 ml, 280ml, 300 ml, 310 ml, 380 ml, 400 ml, 550 ml, 600 ml.**

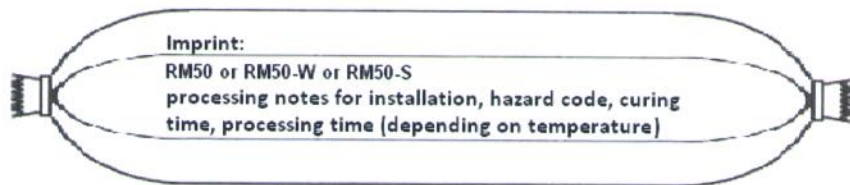

**Mixer for foil capsule (RAWL CFS system)**

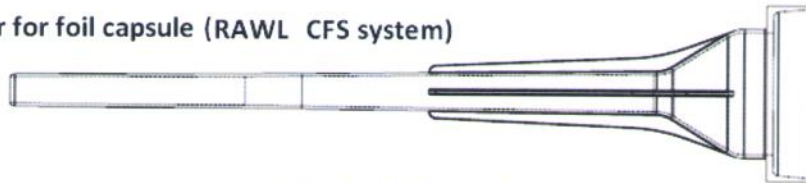

**Mixer standard plus adapter CFS+ for foil capsule**



**Gun for foil capsule (RAWL CFS system)**

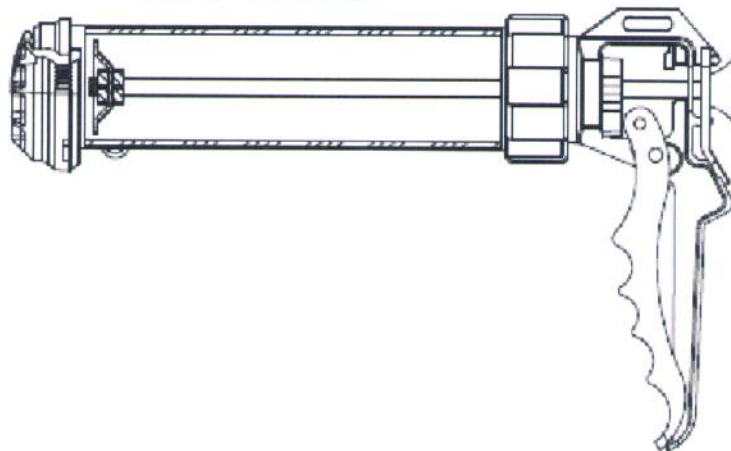

**RAWL R-KEM II / RAWL R-KEM II-S / RAWL R-KEM II-W  
and RAWL RM50 / RAWL RM50-S / RAWL RM50-W**

Cartridge types and sizes (2)

**Annex 3**  
of European  
Technical Approval  
ETA-12/0394

**Additional mixer extension**

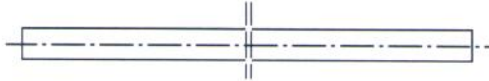

\*Variable length from 300mm up to 1000mm.

**Manual blower pump**

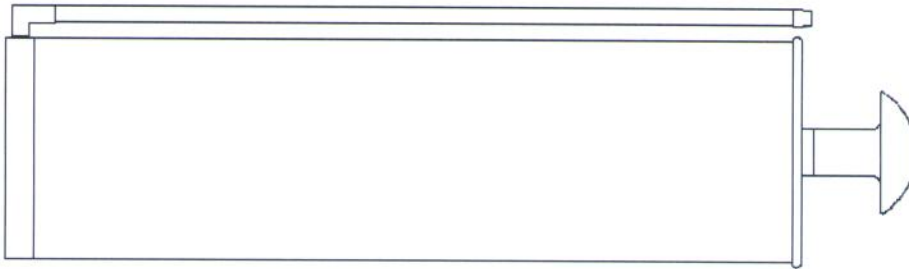

**Steel brush**



**Brush diameter**

Size rod	M8	M10	M12	M16	M20	M24	M30
Brushes diameter $d_b$ (mm)	12	14	16	20	26	30	37

**RAWL R-KEM II / RAWL R-KEM II-S / RAWL R-KEM II-W  
 and RAWL RM50 / RAWL RM50-S / RAWL RM50-W**

Tools

**Annex 4**  
 of European  
 Technical Approval  
 ETA-12/0394

**Table 1: Materials**

Part	Designation		
	Steel, zinc plated	Stainless steel	High corrosion resistance stainless steel
Anchor rod	Steel, property class 5.8 to 12.9, acc. to EN ISO 898-1; zinc plated $\geq 5 \mu\text{m}$ acc. to EN ISO 4042 or hot-dip galvanized $\geq 45 \mu\text{m}$ acc. to EN ISO 10684	Material 1.4401, 1.4404, 1.4571 acc. to EN 10088; property class 70 and 80 (A4-70 and A4-80) acc. to EN ISO 3506	Material 1.4529, 1.4565, 1.4547 acc. to EN 10088; property class 70 acc. to EN ISO 3506
Hexagon nut	Steel, property class 5 to 12, acc. to EN 20898-2; zinc plated $\geq 5 \mu\text{m}$ acc. to EN ISO 4042 or hot-dip galvanized $\geq 45 \mu\text{m}$ acc. to EN ISO 10684	Material 1.4401, 1.4404, 1.4571 acc. to EN 10088; property class 70 and 80 (A4-70 and A4-80) acc. to EN ISO 3506	Material 1.4529, 1.4565, 1.4547 acc. to EN 10088; property class 70 acc. to EN ISO 3506
Washer	Steel, acc. to EN ISO 7089; zinc plated $\geq 5 \mu\text{m}$ acc. to EN ISO 4042 or hot-dip galvanized $\geq 45 \mu\text{m}$ acc. to EN ISO 10684	Material 1.4401, 1.4404, 1.4571 acc. to EN 10088; corresponding to anchor rod material	Material 1.4529, 1.4565, 1.4547 acc. to EN 10088; corresponding to anchor rod material
Injection mortar	Bonding agent: polyester resin styrene free Hardener: dibenzoyl peroxide Additive: quartz sand Delivered in three colours: standard, grey (G) and stone (ST)		

Commercial standard threaded rods (in the case of rods made of galvanized steel – standard rods of the strength class  $\leq 8.8$  only) with:

- material and mechanical properties according to Table 1,
- confirmation of material and mechanical properties by inspection certificate 3.1 according to EN-10204:2004,
- marking of the threaded rod with the embedment depth.

**Table 2: Curing time and processing time**

Mortar temperature	Concrete temperature	Processing time [minutes]			Minimum curing time <sup>1)</sup> [minutes]		
		R-KEM II / RM50	R-KEM II-S / RM50-S	R-KEM II-W / RM50-W	R-KEM II / RM50	R-KEM II-S / RM50-S	R-KEM II-W / RM50-W
5°C	-20°C	-	-	45	-	-	1440
5°C	-15°C	-	-	30	-	-	1080
5°C	-10°C	-	-	20	-	-	480
5°C	-5°C	70	180	11	480	1440	300
5°C	0°C	45	120	7	240	1080	120
5°C	5°C	25	60	5	120	720	60
10°C	10°C	15	45	2	90	480	45
15°C	15°C	9	25	1,5	60	360	30
20°C	20°C	5	15	1	45	240	15
25°C	30°C	2	7	-	30	90	-
25°C	35°C	-	6	-	-	60	-
25°C	40°C	-	5	-	-	45	-

<sup>1)</sup> curing time shall be doubled for wet concrete

**RAWL R-KEM II / RAWL R-KEM II-S / RAWL R-KEM II-W  
 and RAWL RM50 / RAWL RM50-S / RAWL RM50-W**

Materials, curing time and processing time

**Annex 5**  
 of European  
 Technical Approval  
 ETA-12/0394

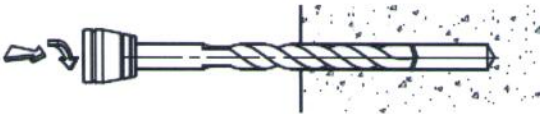

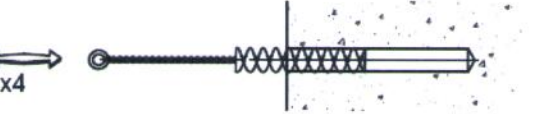
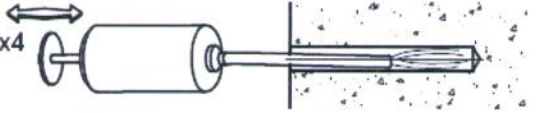



**Table 3: Installation parameters of anchor rods**

Anchor rods			M8	M10	M12	M16	M20	M24	M30
Diameter of anchor rod	d	[mm]	8	10	12	16	20	24	30
Drilling diameter	d <sub>0</sub>	[mm]	10	12	14	18	24	28	35
Diameter of the hole in the fixture	d <sub>fix</sub>	[mm]	9	12	14	18	22	26	32
Depth of the drilling hole	h <sub>0</sub>	[mm]	h <sub>ef</sub> + 5 mm						
Embedment depth	h <sub>ef, min</sub>	[mm]	60	70	80	100	120	140	165
	h <sub>ef, max</sub>	[mm]	100	120	145	190	240	290	360
Minimum thickness of the concrete	h <sub>min</sub>	[mm]	h <sub>ef</sub> + 2 · d <sub>0</sub> ≥ 100 mm						
Torque moment	T <sub>inst</sub>	[Nm]	10	20	40	80	120	180	300
<b>Minimum spacing and edge distance</b>									
Minimum spacing	s <sub>min</sub>	[mm]	0,5 · h <sub>ef</sub> ≥ 40 mm						
Minimum edge distance	c <sub>min</sub>	[mm]	0,5 · h <sub>ef</sub> ≥ 40 mm						

**RAWL R-KEM II / RAWL R-KEM II-S / RAWL R-KEM II-W  
 and RAWL RM50 / RAWL RM50-S / RAWL RM50-W**

Installation parameters

**Annex 6**  
 of European  
 Technical Approval  
 ETA-12/0394

	<p>Drill a hole to the required diameter and depth using a rotary hammer drilling machine.</p>	
	<p>Starting from the drill hole bottom blow the hole at least 4 times using the hand pump.</p>	
	<p>Using the specified brush, mechanically brush out the hole at least 4 times.</p>	
	<p>Starting from the drill hole bottom, blow at least 4 times with the hand pump.</p>	
	<p>Insert the mixing nozzle to the far end of the hole and inject the mortar, slowly withdrawing the nozzle as the hole is filled to 2/3 of its' depth.</p>	
	<p>Immediately insert the rod, slowly and with a slight twisting motion. Remove excess of mortar around the hole before it sets.</p>	
	<p>Leave the fixing undisturbed until the cure time elapses.</p>	
	<p>Attach the fixture and tighten the nut to the required torque.</p>	
<p><b>RAWL R-KEM II / RAWL R-KEM II-S / RAWL R-KEM II-W                  and RAWL RM50 / RAWL RM50-S / RAWL RM50-W</b></p>		<p><b>Annex 7</b>                  of European                  Technical Approval                  ETA-12/0394</p>
<p>Installation instruction</p>		



**Table 4: Characteristic values of resistance to tension loads**

Size			M8	M10	M12	M16	M20	M24	M30	
<b>Steel failure</b>										
Steel failure with standard threaded rod grade 5.8										
Characteristic resistance	$N_{Rk,s}$	[kN]	18	29	42	78	122	176	280	
Partial safety factor	$\gamma_{Ms}^{1)}$	[-]	1,50							
Steel failure with standard threaded rod grade 8.8										
Characteristic resistance	$N_{Rk,s}$	[kN]	29	46	67	126	196	282	449	
Partial safety factor	$\gamma_{Ms}^{1)}$	[-]	1,50							
Steel failure with standard threaded rod grade 10.9										
Characteristic resistance	$N_{Rk,s}$	[kN]	37	58	84	157	245	353	561	
Partial safety factor	$\gamma_{Ms}^{1)}$	[-]	1,40							
Steel failure with standard threaded rod grade 12.9										
Characteristic resistance	$N_{Rk,s}$	[kN]	44	70	101	188	294	424	673	
Partial safety factor	$\gamma_{Ms}^{1)}$	[-]	1,40							
Steel failure with standard stainless steel threaded rod A4-70										
Characteristic resistance	$N_{Rk,s}$	[kN]	26	41	59	110	171	247	393	
Partial safety factor	$\gamma_{Ms}^{1)}$	[-]	1,87							
Steel failure with standard stainless steel threaded rod A4-80										
Characteristic resistance	$N_{Rk,s}$	[kN]	29	46	67	126	196	282	449	
Partial safety factor	$\gamma_{Ms}^{1)}$	[-]	1,60							
Steel failure with standard high corrosion threaded rod grade 70										
Characteristic resistance	$N_{Rk,s}$	[kN]	26	41	59	110	171	247	393	
Partial safety factor	$\gamma_{Ms}^{1)}$	[-]	1,87							
<b>Combined pull-out and concrete cone failure</b>										
Characteristic bond resistance in non-cracked concrete C20/25										
Temperature range I: 40°C/24°C	$\tau_{Rk,ucr}$	[N/mm <sup>2</sup> ]	9,5	9,5	9,0	8,0	8,0	6,5	5,5	
Temperature range II: 80°C/50°C	$\tau_{Rk,ucr}$	[N/mm <sup>2</sup> ]	8,0	8,0	7,5	7,0	6,5	5,0	4,5	
Increasing factor for $\tau_{Rk,ucr}$ in non-cracked concrete	$\psi_c$	C30/37	1,04				1,0			
		C40/50	1,07				1,0			
		C50/60	1,09				1,0			
Partial safety factors for use category 1 + 2	$\gamma_{Mc} = \gamma_{Mp}$	[-]	2,1	1,8	1,8	1,8	1,8	1,8	1,8	
<b>Splitting failure</b>										
Effective anchorage depth $h_{ef}$	min	[mm]	60	70	80	100	120	140	165	
	max	[mm]	100	120	145	190	240	290	360	
Edge distance	$c_{cr,N} = c_{cr,Np}$	[mm]	$c_{cr,Np} = \frac{s_{cr,Np}}{2}$							
	$c_{cr,sp}$ for $h_{min}$	[mm]	$2,5 \cdot h_{ef}$	$2,0 \cdot h_{ef}$	$1,5 \cdot h_{ef}$					
	$c_{cr,sp}$ for $h_{min} < h^2) < 2 \cdot h_{ef}$ ( $c_{cr,sp}$ from linear interpolation)	[mm]								
	$c_{cr,sp}$ for $h^2) \geq 2 \cdot h_{ef}$	[mm]	$c_{cr,Np}$							
Spacing	$s_{cr,N} = s_{cr,Np}$	[mm]	$s_{cr,Np} = 20 \cdot d \cdot \left( \frac{f_{Rk,ucr}}{7,5} \right)^{0,5} \leq 3 \cdot h_{ef}$							
	$s_{cr,sp}$	[mm]	$2,0 \cdot c_{cr,sp}$							

<sup>1)</sup> in the absence of national regulations

<sup>2)</sup> h – concrete member thickness

**RAWL R-KEM II / RAWL R-KEM II-S / RAWL R-KEM II-W  
 and RAWL RM50 / RAWL RM50-S / RAWL RM50-W**

Characteristic resistance under tension loads – design method A

**Annex 8**  
 of European  
 Technical Approval  
 ETA-12/0394

**Table 5: Shear loads for steel failure without lever arm**

Size			M8	M10	M12	M16	M20	M24	M30
<b>Steel failure with standard threaded rod grade 5.8</b>									
Characteristic resistance	$V_{Rk,s}$	[kN]	9	14	21	39	61	88	140
Partial safety factor	$\gamma_{Ms}$	[-]	1,25						
<b>Steel failure with standard threaded rod grade 8.8</b>									
Characteristic resistance	$V_{Rk,s}$	[kN]	15	23	34	63	98	141	224
Partial safety factor	$\gamma_{Ms}$	[-]	1,25						
<b>Steel failure with standard threaded rod grade 10.9</b>									
Characteristic resistance	$V_{Rk,s}$	[kN]	18	29	42	78	122	176	280
Partial safety factor	$\gamma_{Ms}$	[-]	1,50						
<b>Steel failure with standard threaded rod grade 12.9</b>									
Characteristic resistance	$V_{Rk,s}$	[kN]	22	35	51	94	147	212	337
Partial safety factor	$\gamma_{Ms}$	[-]	1,50						
<b>Steel failure with standard stainless steel threaded rod A4-70</b>									
Characteristic resistance	$V_{Rk,s}$	[kN]	13	20	29	55	86	124	196
Partial safety factor	$\gamma_{Ms}$	[-]	1,56						
<b>Steel failure with standard stainless steel threaded rod A4-80</b>									
Characteristic resistance	$V_{Rk,s}$	[kN]	15	23	34	63	98	141	224
Partial safety factor	$\gamma_{Ms}$	[-]	1,33						
<b>Steel failure with high corrosion stainless steel threaded rod grade 70</b>									
Characteristic resistance	$V_{Rk,s}$	[kN]	13	20	29	55	86	124	196
Partial safety factor	$\gamma_{Ms}$	[-]	1,56						

**RAWL R-KEM II / RAWL R-KEM II-S / RAWL R-KEM II-W  
 and RAWL RM50 / RAWL RM50-S / RAWL RM50-W**

Characteristic resistance under shear loads – design method A

**Annex 9**  
 of European  
 Technical Approval  
 ETA-12/0394

**Table 6: Shear loads for steel failure with lever arm**

Size			M8	M10	M12	M16	M20	M24	M30
<b>Steel failure with standard threaded rod grade 5.8</b>									
Characteristic resistance	$M_{Rk,s}^0$	[Nm]	19	37	65	166	324	561	1124
Partial safety factor	$\gamma_{Ms}$	[-]	1,25						
<b>Steel failure with standard threaded rod grade 8.8</b>									
Characteristic resistance	$M_{Rk,s}^0$	[Nm]	30	60	105	266	519	898	1799
Partial safety factor	$\gamma_{Ms}$	[-]	1,25						
<b>Steel failure with standard threaded rod grade 10.9</b>									
Characteristic resistance	$M_{Rk,s}^0$	[Nm]	37	75	131	333	649	1123	2249
Partial safety factor	$\gamma_{Ms}$	[-]	1,50						
<b>Steel failure with standard threaded rod grade 12.9</b>									
Characteristic resistance	$M_{Rk,s}^0$	[Nm]	45	90	157	400	779	1347	2699
Partial safety factor	$\gamma_{Ms}$	[-]	1,50						
<b>Steel failure with standard stainless steel threaded rod A4-70</b>									
Characteristic resistance	$M_{Rk,s}^0$	[Nm]	26	52	92	233	454	786	1574
Partial safety factor	$\gamma_{Ms}$	[-]	1,56						
<b>Steel failure with standard stainless steel threaded rod A4-80</b>									
Characteristic resistance	$M_{Rk,s}^0$	[Nm]	30	60	105	266	519	898	1799
Partial safety factor	$\gamma_{Ms}$	[-]	1,33						
<b>Steel failure with high corrosion stainless steel threaded rod grade 70</b>									
Characteristic resistance	$M_{Rk,s}^0$	[Nm]	26	52	92	233	454	786	1574
Partial safety factor	$\gamma_{Ms}$	[-]	1,56						

**RAWL R-KEM II / RAWL R-KEM II-S / RAWL R-KEM II-W  
 and RAWL RM50 / RAWL RM50-S / RAWL RM50-W**

Characteristic resistance under shear loads – design method A

**Annex 10**  
 of European  
 Technical Approval  
 ETA-12/0394

**Table 7: Concrete pry out failure and concrete edge failure**

Size			M8	M10	M12	M16	M20	M24	M30
Effective anchorage depth $h_{ef}$	min	[mm]	60	70	80	100	120	140	165
	max	[mm]	100	120	145	190	240	290	360
<b>Pry out failure</b>									
Factor	k	[-]	2	2	2	2	2	2	2
Partial safety factor	$\gamma_{Mp}$	[-]	1,5						
<b>Concrete edge failure: see clause 5.2.3.4 of Technical Report TR 029</b>									
Partial safety factor	$\gamma_{Mc}$	[-]	1,5						

**Table 8: Displacement under tension and shear loads**

Size			M8	M10	M12	M16	M20	M24	M30
<b>Characteristic displacement in non-cracked C20/25 to C50/60 concrete</b>									
Admissible service load <sup>1)</sup>	F	[kN]	6,5	9,4	12,3	18,8	27,1	26,2	32,5
Displacement	$\delta_{N0}$	[mm]	0,20	0,25	0,30	0,35	0,40	0,40	0,45
	$\delta_{N\infty}$	[mm]	0,85	0,85	0,85	0,85	0,85	0,85	0,85

<sup>1)</sup>  $F = F_{Rk} / \gamma_F \cdot \gamma_{Mc}$ , with  $\gamma_F = 1,4$

**RAWL R-KEM II / RAWL R-KEM II-S / RAWL R-KEM II-W  
 and RAWL RM50 / RAWL RM50-S / RAWL RM50-W**

Characteristic resistance under shear loads – design method A.  
 Displacement under service loads: tension and shear

**Annex 11**  
 of European  
 Technical Approval  
 ETA-12/0394