

3478DVR200P63

EAN 4031582030181

Fixed castor, Fork made of pressed steel, bright zinc plated, blue passivated, wheel axle with nut, plate fitting.

Wheel centre made of pressed steel, Tread: solid rubber, black, roller bearing

Technical Data

Wheel diameter	200 mm
Width of Tread	50 mm
Size of Plate	137 x 115 mm
Plate hole centres	105 x 80/75 mm
Plate hole	11 mm
Overall height	240 mm
Temperature	- 20 / + 60 °C
Standard	EN 12532
Weight	2.839 kg
Hardness of tread	Shore A 85
Load capacity	205 kg
Load capacity (static)	410 kg

Roll performance	+	+	+	+	+
Movement noise	+	+	+	+	+
Attrition	+	+	+	+	+
Corrosion resistance	+	+	+	+	+

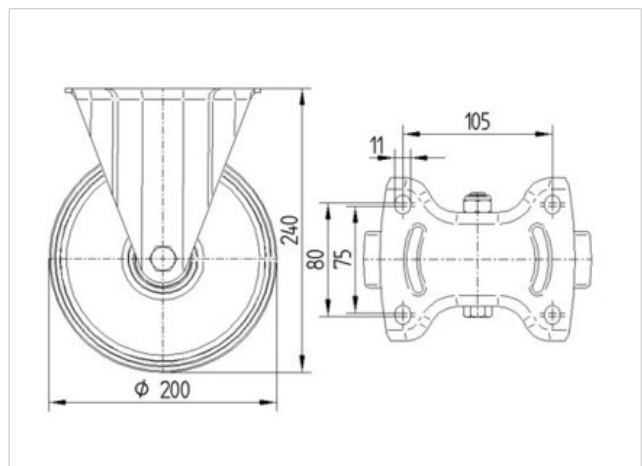



3478DVR200P63

EAN 4031582030181

